

# LAMBRO

Rozsdamentes dekorációs profilok



# Tartalomjegyzék

## KLASSZIKUS PROFILOK

Klasszikus dekor profilok <b>C</b>	2-5
Dekoratív Díszítés <b>I</b>	6-9
Sarokprofilok <b>L</b>	10-13
Belső sarokprofilok <b>Li</b>	14-17
Élzáró profil <b>J</b>	18-21
Sarokprofilok <b>Q</b>	22-25
Sarokprofil végzárók <b>PQ</b>	26-29

## SZÖGLETES - RETIFIKÁLT PROFILOK

Szögletes dekor profilok <b>U</b>	32-35
Szögletes élzáró profil <b>Js</b>	36-39
Szögletes sarokprofilok <b>Qs</b>	40-43
45° -os sarokprofil <b>Rs</b>	44-47
Burkolatváltó profilok <b>Ts</b>	48-51

## ZUHANYPROFILOK

Lejtőprofilok - külső <b>LK</b>	54-57
Lejtőprofil zuhanyüveghez <b>LPS</b>	58-61
Zuhanyfal üveg profil <b>LSS</b>	62-65
Lejtőprofilok - belső (fali) <b>LS</b>	66-69
Zuhany dekorprofil - belső (fali) <b>LC</b>	70-73
Utólagos zuhanyfal üveg profil <b>LM</b>	74-77

## Dekoratív elemek

Hexagon	78-81
---------	-------

## Gyakran feltett kérdések 82

# LAMBRO

# "C" Profil

Klasszikus dekor profil

Polír – Fényes

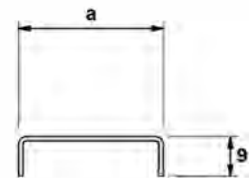

a 10, 20, 40



SZÍN

méret (mm) :

cikkszám

magasság: 9 mm

	EZÜST	ARANY	ANTRACIT	RÉZ
10 x 2700	10 x 2700	10 x 2700	10 x 2700	10 x 2700
C-10-2700-SILVER-MI	C-10-2700-GOLD-MI	C-10-2700-BLACK-MI	C-10-2700-COPPER-MI	
20 x 2700	20 x 2700	20 X2700	20 x 2700	
C-20-2700-SILVER-MI	C-20-2700-GOLD-MI	C-20-2700-BLACK-MI	C-20-2700-COPPER-MI	
40 x 2700	40 x 2700	40 x 2700	40 X2700	
C-40-2700-SILVER-MI	C-40-2700-GOLD-MI	C-40-2700-BLACK-MI	C-40-2700-COPPER-MI	

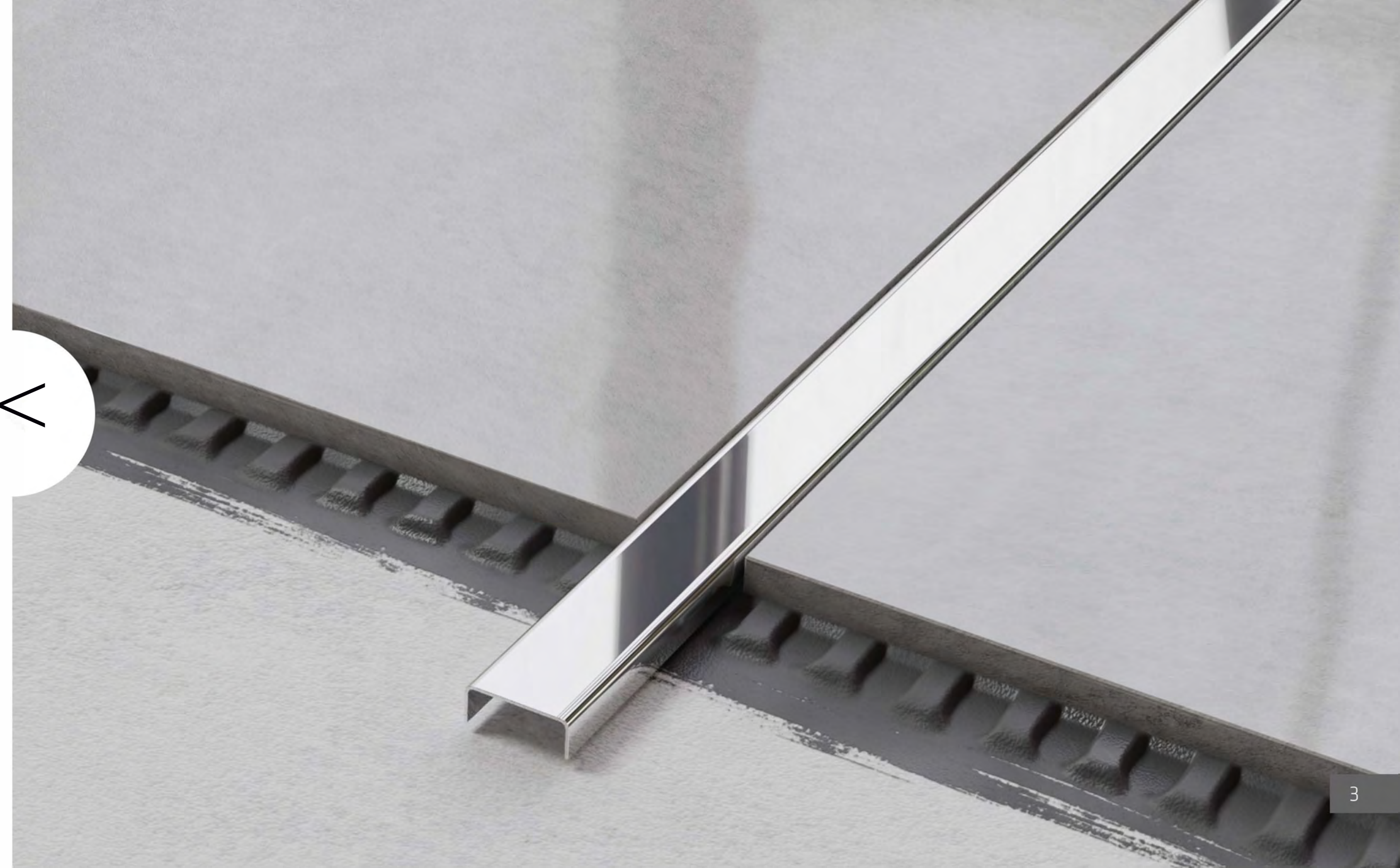

# "C" Profil

Klasszikus dekor profil

Szálcsiszolt

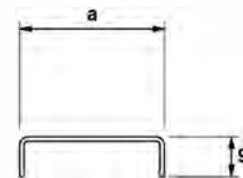

a= 10, 20, 40



SZÍN

szélesség: [mm]

cikkszám

magasság: 9 mm

	EZÜST	ARANY	ANTRACIT	RÉZ
10 x 2700	10 x 2700	10 x 2700	10 x 2700	10 x 2700
<i>C-10-2700-SILVER-BR</i>	<i>C-10-2700-GOLD-BR</i>	<i>C-10-2700-BLACK-BR</i>	<i>C-10-2700-COPPER-BR</i>	
20 x 2700	20 x 2700	20 x 2700	20 x 2700	20 x 2700
<i>C-20-2700-SILVER-BR</i>	<i>C-20-2700-GOLD-BR</i>	<i>C-20-2700-BLACK-BR</i>	<i>C-20-2700-COPPER-BR</i>	
40 x 2700	40 x 2700	40 x 2700	40 x 2700	40 x 2700
<i>C-40-2700-SILVER-BR</i>	<i>C-40-2700-GOLD-BR</i>	<i>C-40-2700-BLACK-BR</i>	<i>C-40-2700-COPPER-BR</i>	

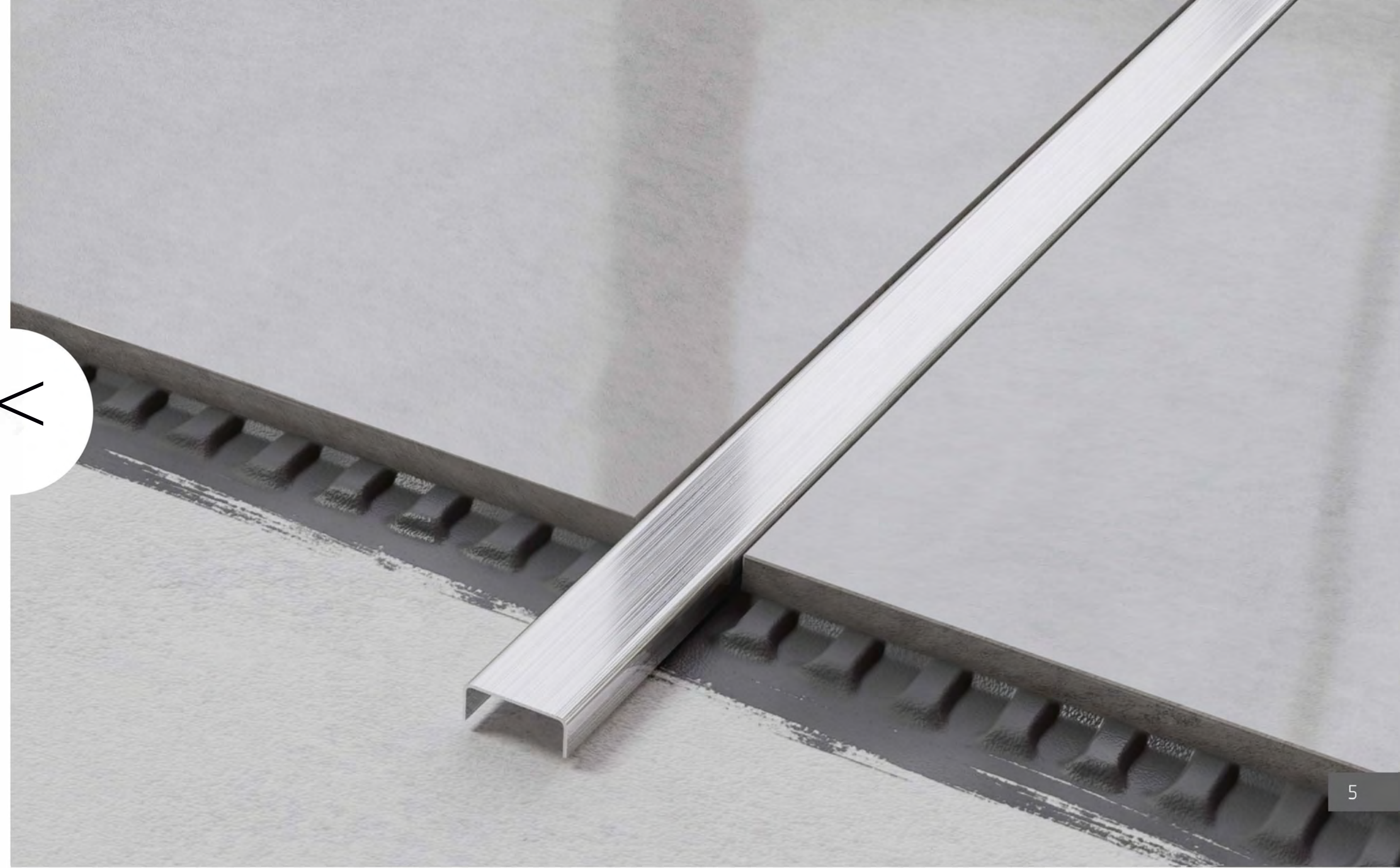

# 'I' PROFIL

Díszítő profil

Polír - fényes

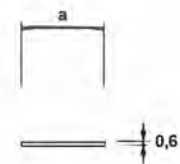

SZÍN:

szélesség: [mm]

cikkszám

magasság: 0,6 mm

	EZÜST	ARANY	ANTRACIT	RÉZ
10 x 2700	10 x 2700	10 x 2700	10 x 2700	10 x 2700
<i>I-10-2700-SILVER-MI</i>	<i>I-10-2700-GOLD-MI</i>	<i>I-10-2700-BLACK-MI</i>	<i>I-10-2700-COPPER-MI</i>	
20 x 2700	20 x 2700	20 x 2700	20 x 2700	20 x 2700
<i>I-20-2700-SILVER-MI</i>	<i>I-20-2700-GOLD-MI</i>	<i>I-20-2700-BLACK-MI</i>	<i>I-20-2700-COPPER-MI</i>	
28 x 2700	28 x 2700	28 x 2700	28 x 2700	28 x 2700
<i>I-28-2700-SILVER-MI</i>	<i>I-28-2700-GOLD-MI</i>	<i>I-28-2700-BLACK-MI</i>	<i>I-28-2700-COPPER-MI</i>	
38 x 2700	38 x 2700	38 x 2700	38 x 2700	38 x 2700
<i>I-38-2700-SILVER-MI</i>	<i>I-38-2700-GOLD-MI</i>	<i>I-38-2700-BLACK-MI</i>	<i>I-38-2700-COPPER-MI</i>	
50 x 2700	50 x 2700	50 x 2700	50 x 2700	50 x 2700
<i>I-50-2700-SILVER-MI</i>	<i>I-50-2700-GOLD-MI</i>	<i>I-50-2700-BLACK-MI</i>	<i>I-50-2700-COPPER-MI</i>	
100 x 2700	100 x 2700	100 x 2700	100 x 2700	100 x 2700
<i>I-100-2700-SILVER-MI</i>	<i>I-100-2700-GOLD-MI</i>	<i>I-100-2700-BLACK-MI</i>	<i>I-100-2700-COPPER-MI</i>	



# 'I' PROFIL

Díszítő profil

szálcsiszolt

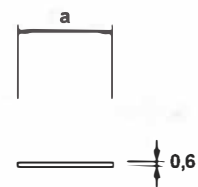

SZÍN:

szélesség [mm]

Cikkszám:

magasság: 0,6 mm

	EZÜST	ARANY	ANTRACIT	RÉZ
<b>10 x 2700</b> <small>I-10-2700-SILVER-BR</small>	<b>10 x 2700</b> <small>I-10-2700-GOLD-BR</small>	<b>10 x 2700</b> <small>I-10-2700-BLACK-BR</small>	<b>10 x 2700</b> <small>I-10-2700-COPPER-BR</small>	
<b>20 x 2700</b> <small>I-20-2700-SILVER-BR</small>	<b>20 x 2700</b> <small>I-20-2700-GOLD-BR</small>	<b>20 x 2700</b> <small>I-20-2700-BLACK-BR</small>	<b>20 x 2700</b> <small>I-20-2700-COPPER-BR</small>	
<b>28 x 2700</b> <small>I-28-2700-SILVER-BR</small>	<b>28 x 2700</b> <small>I-28-2700-GOLD-BR</small>	<b>28 x 2700</b> <small>I-28-2700-BLACK-BR</small>	<b>28 x 2700</b> <small>I-28-2700-COPPER-BR</small>	
<b>38 x 2700</b> <small>I-38-2700-SILVER-BR</small>	<b>38 x 2700</b> <small>I-38-2700-GOLD-BR</small>	<b>38 x 2700</b> <small>I-38-2700-BLACK-BR</small>	<b>38 x 2700</b> <small>I-38-2700-COPPER-BR</small>	
<b>50 x 2700</b> <small>I-50-2700-SILVER-BR</small>	<b>50 x 2700</b> <small>I-50-2700-GOLD-BR</small>	<b>50 x 2700</b> <small>I-50-2700-BLACK-BR</small>	<b>50 x 2700</b> <small>I-50-2700-COPPER-BR</small>	
<b>100 x 2700</b> <small>I-100-2700-SILVER-BR</small>	<b>100 x 2700</b> <small>I-100-2700-GOLD-BR</small>	<b>100 x 2700</b> <small>I-100-2700-BLACK-BR</small>	<b>100 x 2700</b> <small>I-100-2700-COPPER-BR</small>	

# "L" Profil

Sarokprofil

Fényes polír

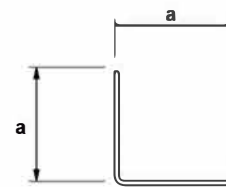

a = 10 / 20



Szín

oldal szélesség [mm]  
cikkszám

EZÜST

**10 x 10 x 2700**  
L-10-2700-SILVER-MI

**20 x 20 x 2700**  
L-20-2700-SILVER-MI

ARANY

**10 x 10 x 2700**  
L-10-2700-GOLD-MI

**20 x 20 x 2700**  
L-20-2700-GOLD-MI

ANTRACIT

**10 x 10 x 2700**  
L-10-2700-BLACK-MI

**20 x 20 x 2700**  
L-20-2700-BLACK-MI

RÉZ

**10 x 10 x 2700**  
L-10-2700-COPPER-MI

**20 x 20 x 2700**  
L-20-2700-COPPER-MI



# "L" Profil

Sarokprofil

szálcsiszolt

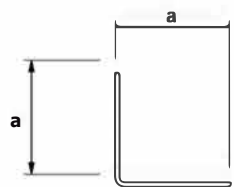

a = 10 / 20



Szín

EZÜST

ARANY

ANTRACIT

RÉZ

oldal szélesség [mm]

10 X10 X2700

L-10-2700-SILVER-BR

10 X10 X2700

L-70-2700-GOLD-BR

10x10x2700

L-10-2700-BLACK-BR

10 X10 X2700

L-70-2700-COPPER-BR

cikkszám

20 X20 X2700

L-20-2700-SILVER-BR

20 X20 X2700

L-20-2700-GOLD-BR

20 X20 X2700

L-20-2700-BLACK-BR

20 X20 X2700

L-20-2700-COPPER-BR





# "Li" Profil

Sarokprofil - belső sarokhoz

Fényes polír

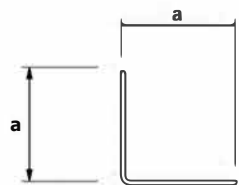

a = 10 / 20



Szín

EZÜST

ARANY

ANTRACIT

RÉZ

oldal szélesség [mm]

10 X10 X2700

10 X10 X2700

10x10x2700

10 X10 X2700

cikkszám

LI-10-2700-SILVER-MI

LI-10-2700-GOLD-MI

LI-10-2700-BLACK-MI

LI-10-2700-COPPER-MI

20 X20 X2700

20 X20 X2700

20 X20 X2700

20 X20 X2700

LI-20-2700-SILVER-MI

LI-20-2700-GOLD-MI

LI-20-2700-BLACK-MI

LI-20-2700-COPPER-MI

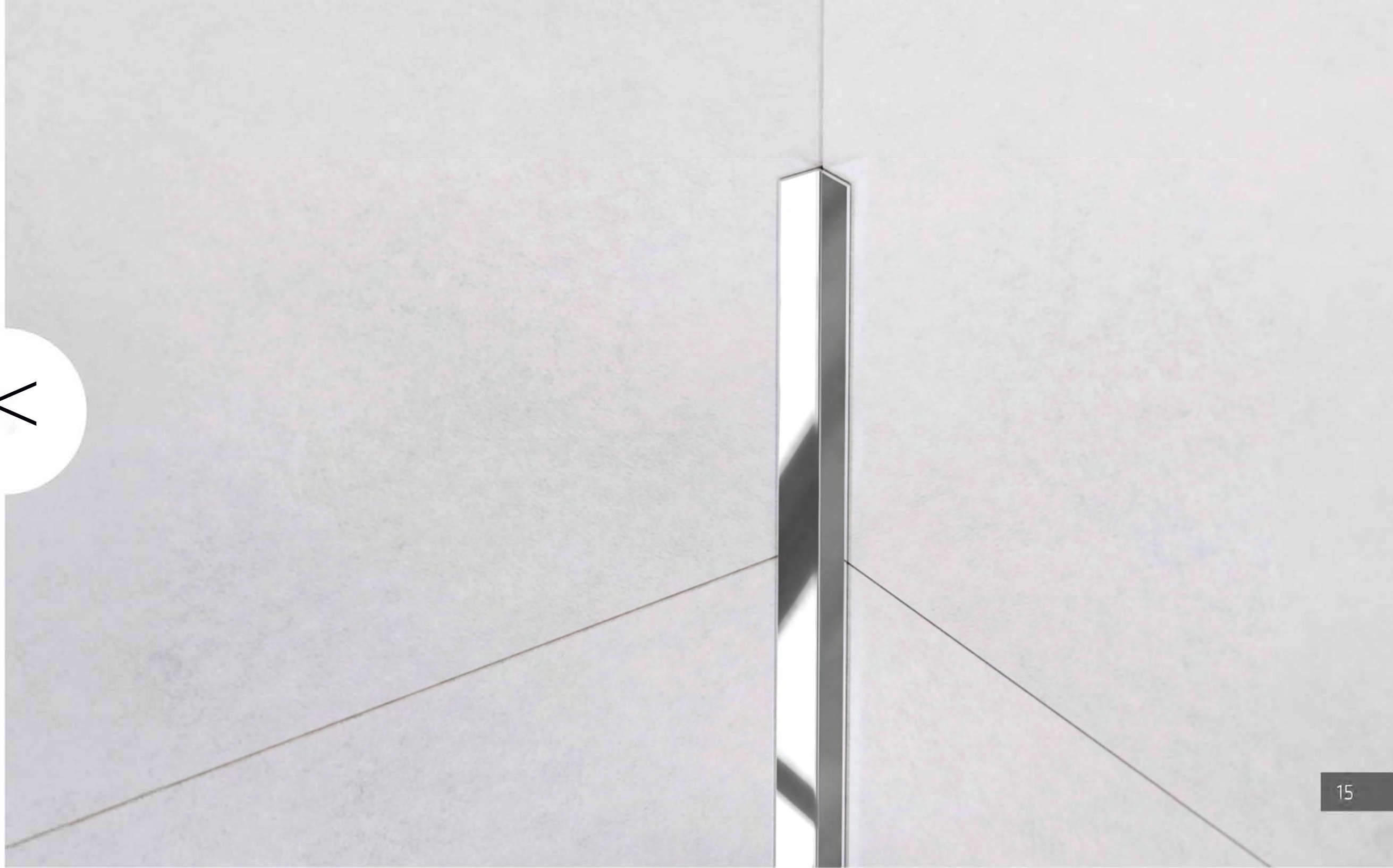

# "Li" Profil

Sarokprofil - belső sarokhoz

Szálcsiszolt

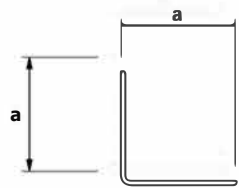

a = 10 / 20



Szín

EZÜST

ARANY

ANTRACIT

RÉZ

oldal szélesség [mm]

10 X10 X2700

10 X10 X2700

10x10x2700

10 X10 X2700

cikkszám

Li-10-2700-SILVER-BR

Li-10-2700-GOLD-BR

Li-10-2700-BLACK-BR

Li-10-2700-COPPER-BR

20 X20 X2700

20 X20 X2700

20 X20 X2700

20 X20 X2700

Li-20-2700-SILVER-BR

Li-20-2700-GOLD-BR

Li-20-2700-BLACK-BR

Li-20-2700-COPPER-BR

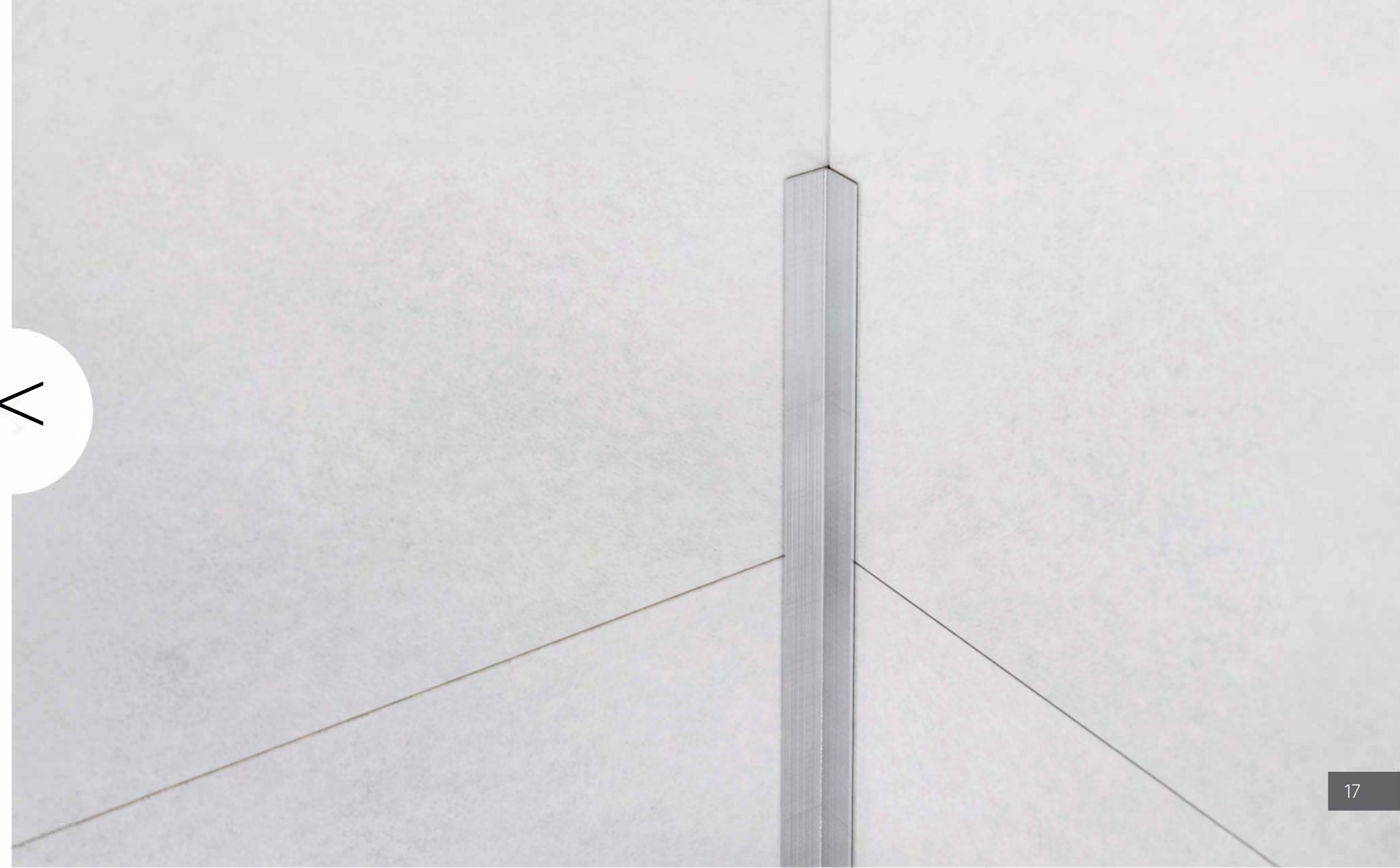
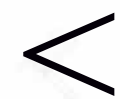

# "J" Profil

Lezáró profil

Fényes polír

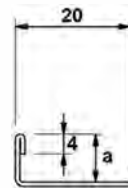

a= 10 / 12



Szín

magasság [mm]  
cikkszám

EZÜST	ARANY	ANTRACIT	RÉZ
10,5 x 2700 <i>J-10-2700-SILVER-MI</i>	10,5 x 2700 <i>J-10-2700-GOLD-MI</i>	10,5 x 2700 <i>J-10-2700-BLACK-MI</i>	10,5 x 2700 <i>J-10-2700-COPPER-MI</i>
12,5 x 2700 <i>J-12-2700-SILVER-MI</i>	12,5 x 2700 <i>J-12-2700-GOLD-MI</i>	12,5 x 2700 <i>J-12-2700-BLACK-MI</i>	12,5 x 2700 <i>J-12-2700-COPPER-MI</i>

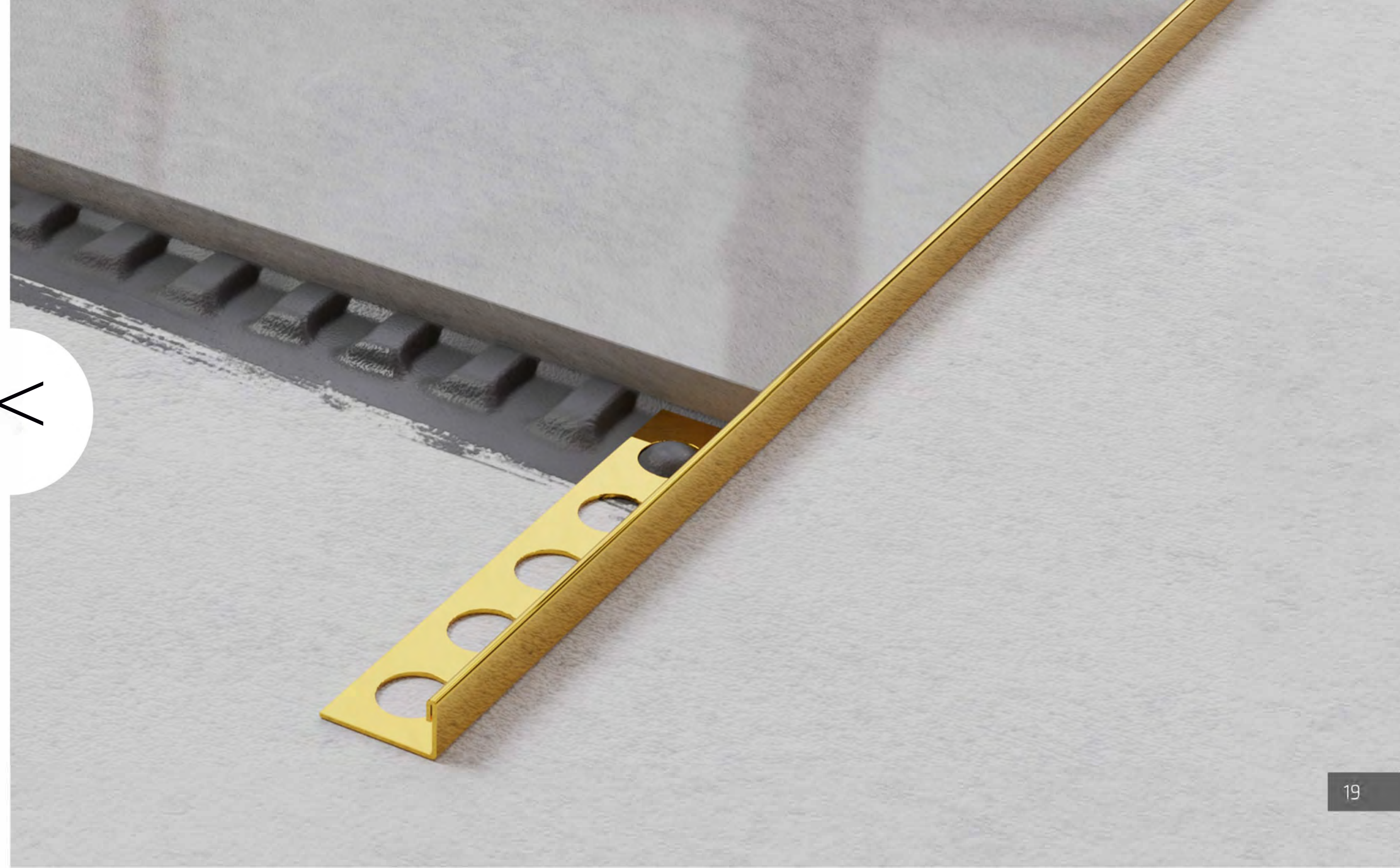

# "J" Profil

Lezáró profil

szálcsiszolt

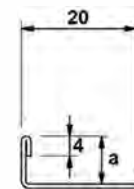

a = 10 / 12

Szín

magasság [mm]  
cikkszám

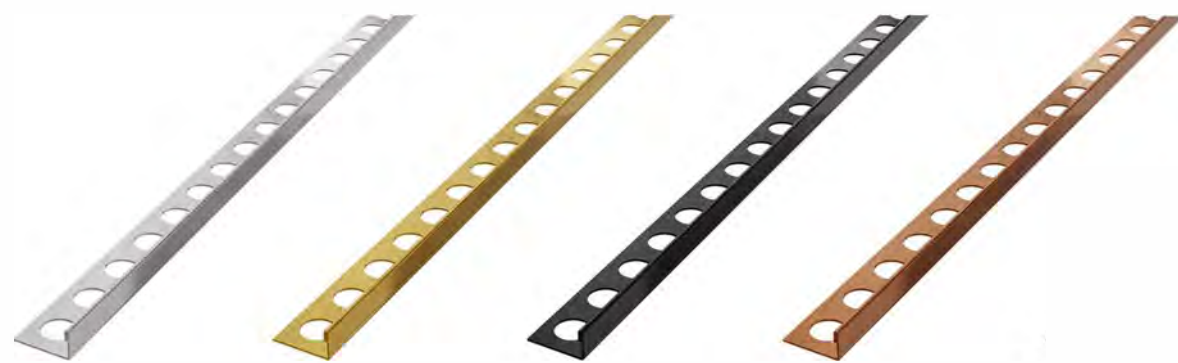

EZÜST	ARANY	ANTRACIT	RÉZ
10,5 x 2700 <small>J-10-2700-SILVER-BR</small>	10,5 x 2700 <small>J-10-2700-GOLD-BR</small>	10,5 x 2700 <small>J-10-2700-BLACK-BR</small>	10,5 x 2700 <small>J-10-2700-COPPER-BR</small>
12,5 x 2700 <small>J-12-2700-SILVER-BR</small>	12,5 x 2700 <small>J-12-2700-GOLD-BR</small>	12,5 x 2700 <small>J-12-2700-BLACK-BR</small>	12,5 x 2700 <small>J-12-2700-COPPER-BR</small>

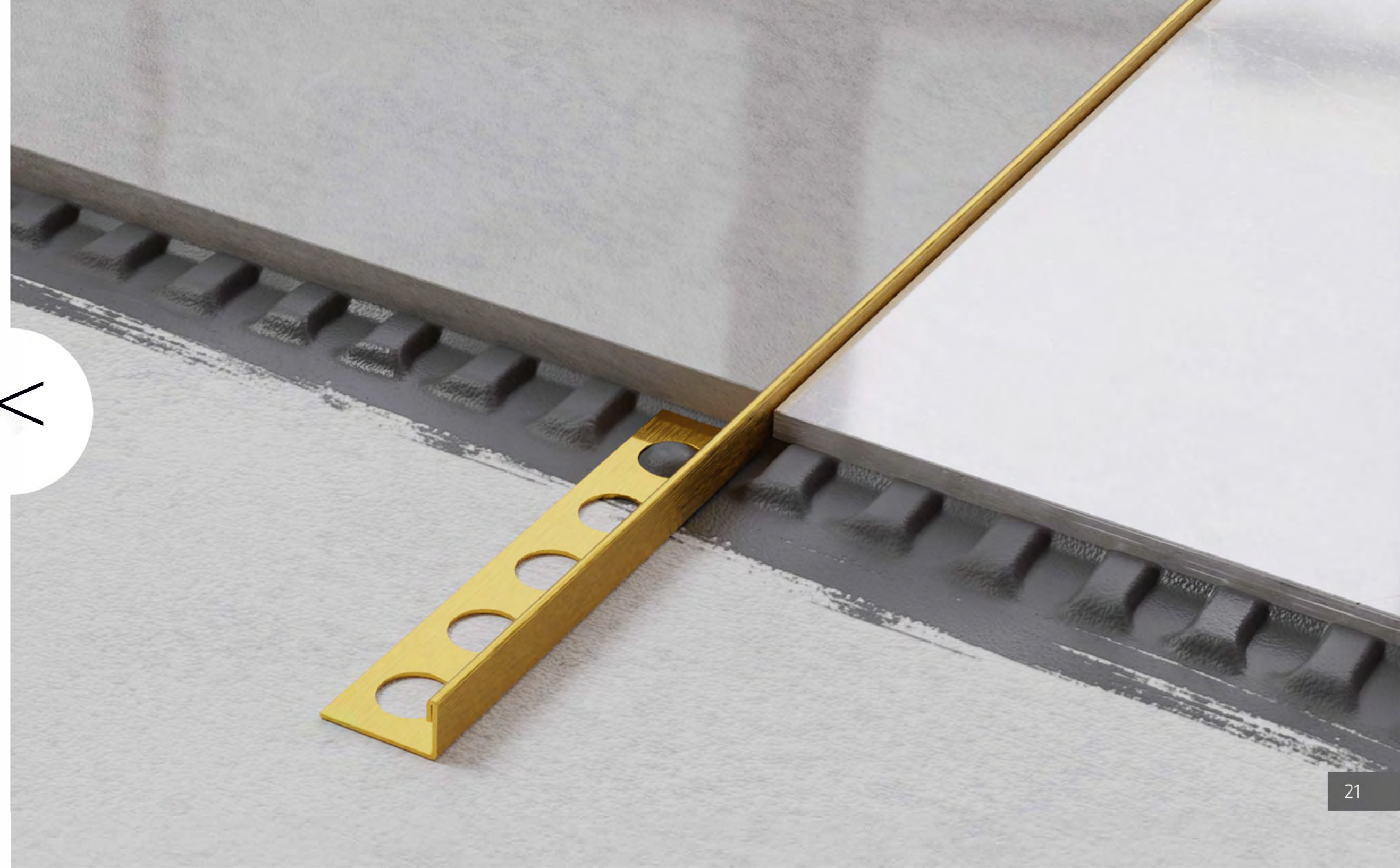

# "Q" Profil

Dekor sarokprofil

Fényes polír

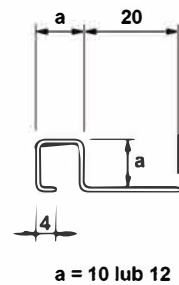

Szín

magasság [mm]  
cikkszám

	EZÜST	ARANY	ANTRACIT	RÉZ
	<b>10,5 x 2700</b> <small>Q-10-2700-SILVER-MI</small>	<b>10,5 x 2700</b> <small>Q-10-2700-GOLD-MI</small>	<b>10,5 x 2700</b> <small>Q-10-2700-BLACK-MI</small>	<b>10,5 x 2700</b> <small>Q-10-2700-COPPER-MI</small>
	<b>12,5 x 2700</b> <small>Q-12-2700-SILVER-MI</small>	<b>12,5 x 2700</b> <small>Q-12-2700-GOLD-MI</small>	<b>12,5 x 2700</b> <small>Q-12-2700-BLACK-MI</small>	<b>12,5 x 2700</b> <small>Q-12-2700-COPPER-MI</small>

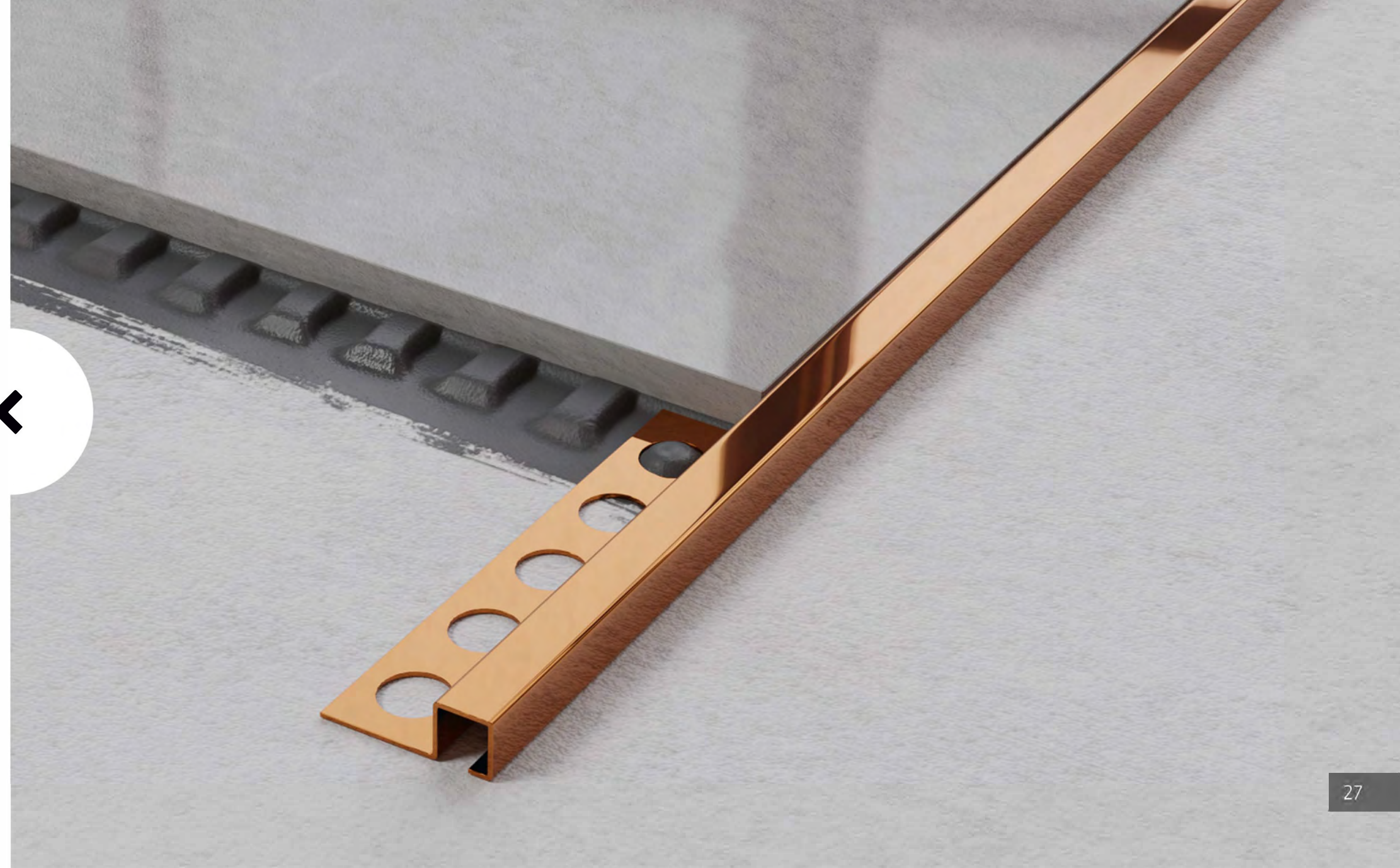

# "Q" Profil

Dekor sarokprofil

Szálcsiszolt

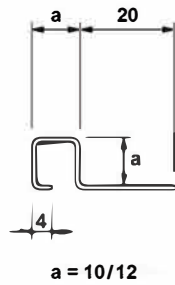

Szín

magasság [mm]  
cikkszám

EZÜST	ARANY	ANTRACIT	RÉZ
<b>10,5 x 2700</b> <small>Q-10-2700-SILVER-BR</small>	<b>10,5 x 2700</b> <small>Q-10-2700-GOLD-BR</small>	<b>10,5 x 2700</b> <small>Q-10-2700-BLACK-BR</small>	<b>10,5 x 2700</b> <small>Q-10-2700-COPPER-BR</small>
<b>12,5 x 2700</b> <small>Q-12-2700-SILVER-BR</small>	<b>12,5 x 2700</b> <small>Q-12-2700-GOLD-BR</small>	<b>12,5 x 2700</b> <small>Q-12-2700-BLACK-BR</small>	<b>12,5 x 2700</b> <small>Q-12-2700-COPPER-BR</small>

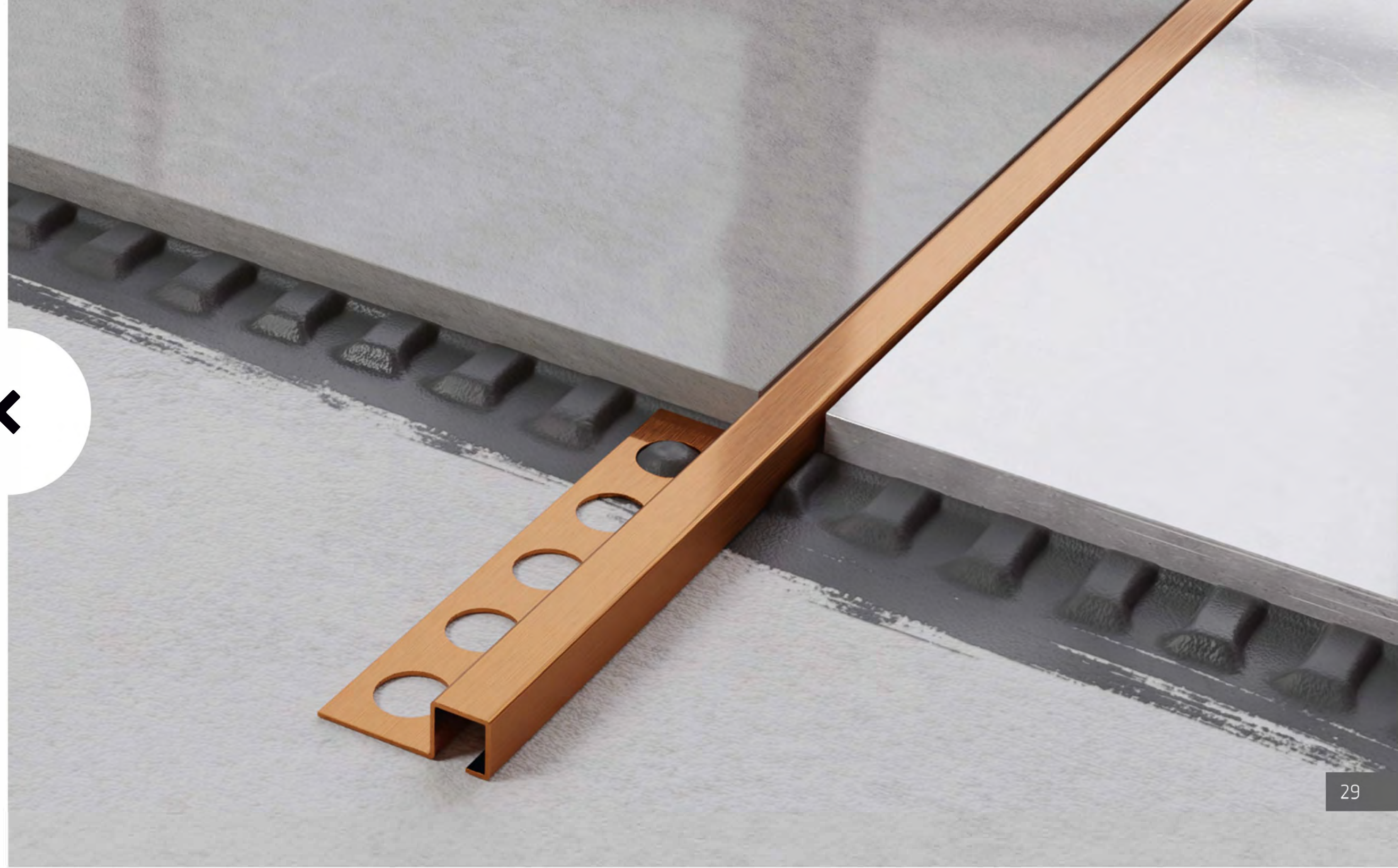

# "PQ" Profil-végzáró

Dekor sarokprofil "Q" végzáró kupak

Fényes polír

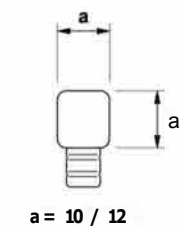

Szín

EZÜST

ARANY

ANTRACIT

RÉZ

**szélesség [mm]**  
cikkszám

**10,5 × 10,5**  
PQ-10-SILVER-MI  
**12,5 × 12,5**  
PQ-12-SILVER-MI

**10,5 × 10,5**  
PQ-10-GOLD-MI  
**12,5 × 12,5**  
PQ-12-GOLD-MI

**10,5 × 10,5**  
PQ-10-BLACK-MI  
**12,5 × 12,5**  
PQ-12-BLACK-MI

**10,5 × 10,5**  
PQ-10-COPPER-MI  
**12,5 × 12,5**  
PQ-12-COPPER-MI

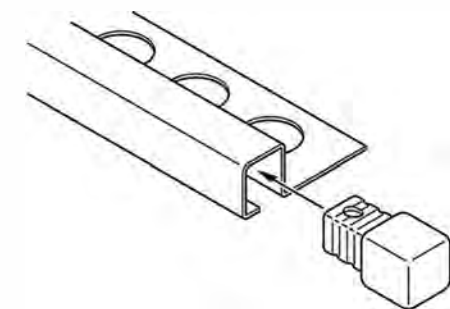

dekoráció rozsdamentes acél fagyálló íves sima felület



# "PQ" Profil-végzáró

Dekor sarokprofil "Q" végzáró kupak

Szálcsiszolt

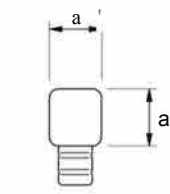

a = 10 / 12



Szín

EZÜST

ARANY

ANTRACIT

RÉZ

**szélesség [mm]**

**10,5 x 10,5**

**10,5 x 10,5**

**10,5 x 10,5**

**10,5 x 10,5**

*cikkszám*

PQ-10-SILVER-BR

PQ-10-GOLD-BR

PQ-10-BLACK-BR

PQ-10-COPPER-BR

**12,5 x 12,5**

**12,5 x 12,5**

**12,5 x 12,5**

**12,5 x 12,5**

PQ-12-SILVER-BR

PQ-12-GOLD-BR

PQ-12-BLACK-BR

PQ-12-COPPER-BR

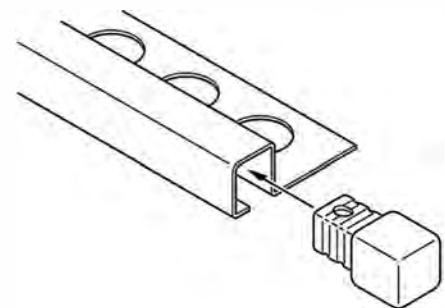



# PRÉMIUM PROFILOK

Prémium szögletes dekorprofilok retifikált csempékhez



# "U" Profil

Szögletes Dekor profil

Fényes polír

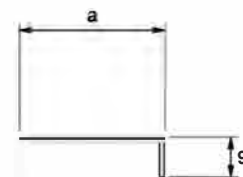

a = 5, 10, 20, 40



Szín

**szélesség [mm]**  
cikkszám

magasság: 9mm

	EZÜST	ARANY	ANTRACIT	RÉZ
5 X 2700 <i>U-5-2700-SILVER-MI</i>	5 X 2700 <i>U-5-2700-GOLD-MI</i>	5 X 2700 <i>U-5-2700-BLACK-MI</i>	5 X 2700 <i>U-5-2700-COPPER-MI</i>	
10 x 2700 <i>U-10-2700-SILVER-MI</i>	10 x 2700 <i>U-10-2700-GOLD-MI</i>	10 x 2700 <i>U-10-2700-BLACK-MI</i>	10 x 2700 <i>U-10-2700-COPPER-MI</i>	
20 x 2700 <i>U-20-2700-SILVER-MI</i>	20 x 2700 <i>U-20-2700-GOLD-MI</i>	20 x 2700 <i>U-20-2700-BLACK-MI</i>	20 x 2700 <i>U-20-2700-COPPER-MI</i>	
40 x 2700 <i>U-40-2700-SILVER-MI</i>	40 x 2700 <i>U-40-2700-GOLD-MI</i>	40 X 2700 <i>U-40-2700-BLACK-MI</i>	40 x 2700 <i>U-40-2700-COPPER-MI</i>	

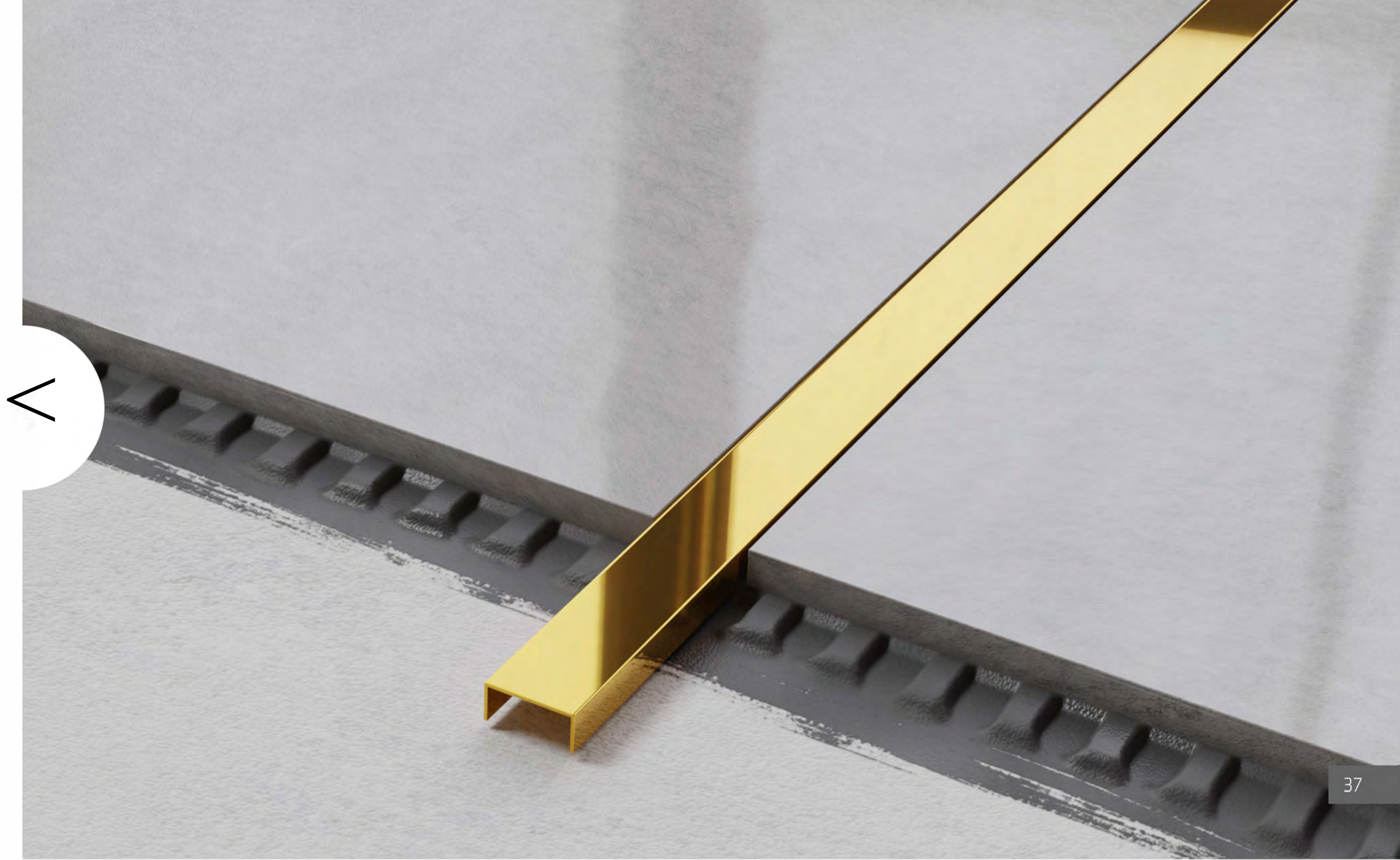

# "U" Profil

Szögletes Dekor profil

Szálcsiszolt

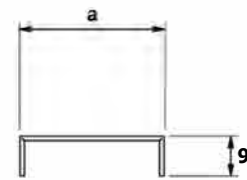

a= 5, 10, 20, 40



Szín

EZÜST

ARANY

ANTRACIT

RÉZ

szélesség [mm]

5 x 2700

5 x 2700

5 x 2700

5 x 2700

cikkszám

U-5-2700-SILVER-BR

U-5-2700-GOLD-BR

U-5-2700-BLACK-BR

U-5-2700-COPPER-BR

10 x 2700

10 x 2700

10 x 2700

10 x 2700

magasság: 9mm

U-10-2700-SILVER-BR

U-10-2700-GOLD-BR

U-10-2700-BLACK-BR

U-10-2700-COPPER-BR

20 x 2700

20 x 2700

20 x 2700

20 x 2700

U-20-2700-SILVER-BR

U-20-2700-GOLD-BR

U-20-2700-BLACK-BR

U-20-2700-COPPER-BR

40 x 2700

40 x 2700

40 x 2700

40 x 2700

U-40-2700-SILVER-BR

U-40-2700-GOLD-BR

U-40-2700-BLACK-BR

U-40-2700-COPPER-BR

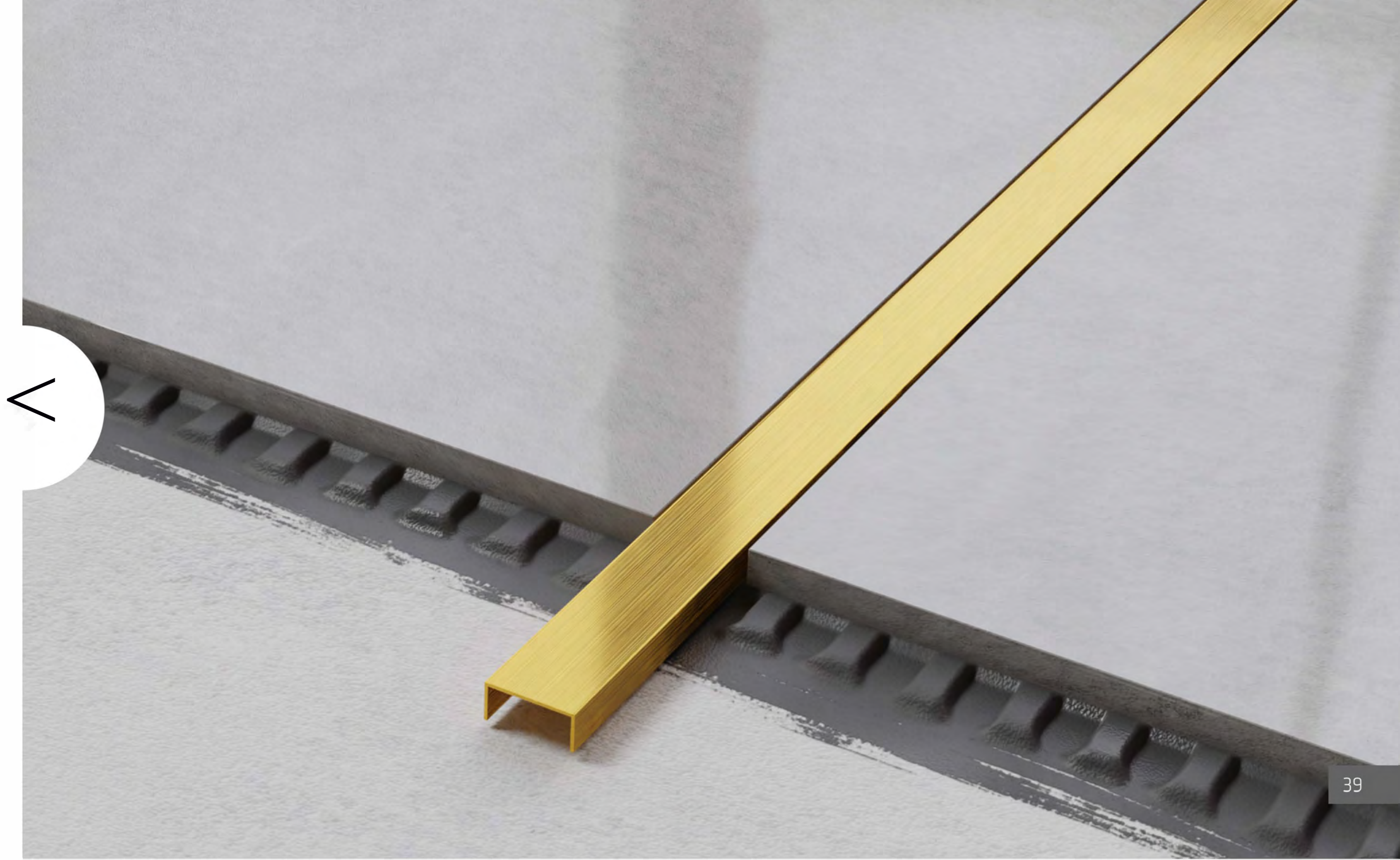

# "Js" Profil

Szögletes lezáró profil,  
+3mm széles

Szálcsiszolt

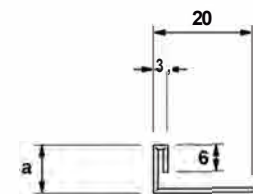

a = 10,5 vagy 12,5



Szín

magasság [mm]  
cikkszám

Szín	EZÜST	ARANY	ANTRACIT	RÉZ
magasság [mm]	10,5 x 2700	10,5 x 2700	10,5 x 2700	10,5 x 2700
cikkszám	Js-10-2700-SILVER-MI	Js-10-2700-GOLO-MI	Js-10-2700-BLACK-MI	Js-10-2700-COPPER-MI
	12,5 x 2700	12,5 x 2700	12,5 x 2700	12,5 x 2700
	Js-12-2700-SILVER-MI	Js-12-2700-GOLO-MI	Js-12-2700-BLACK-MI	Js-12-2700-COPPER-MI

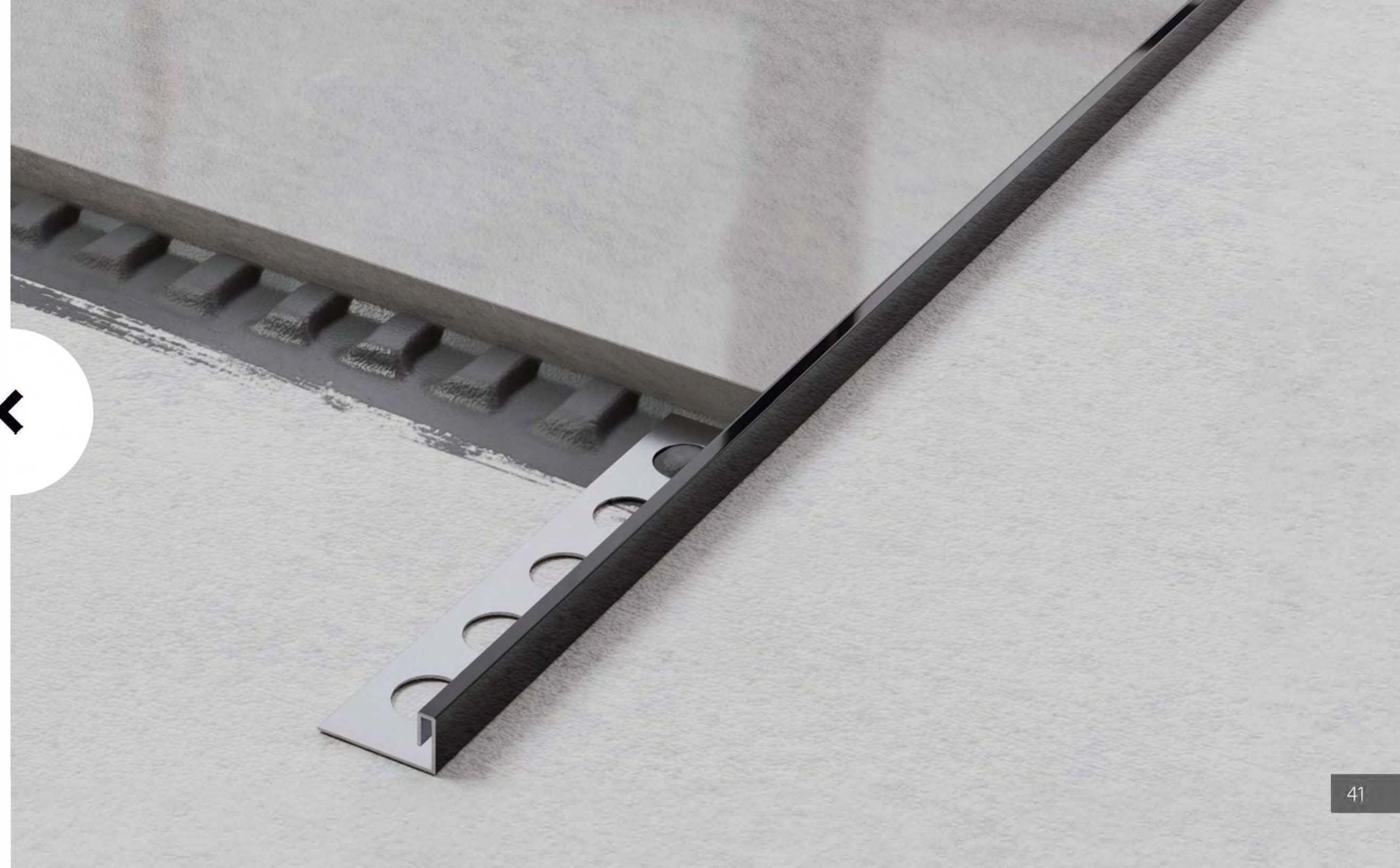

# "Js" Profil

Szögletes lezáró profil,  
+3mm széles

Szálcsiszolt

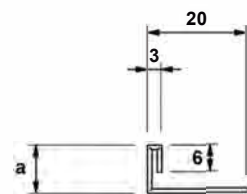

a = 10,5 vagy 12,5



Szín

magasság [mm]  
cikkszám

Szín	EZÜST	ARANY	ANTRACIT	RÉZ
magasság [mm]	10,5 x 2700	10,5 x 2700	10,5 x 2700	10,5 x 2700
cikkszám	<i>Js-10-2700-SILVER-BR</i>	<i>Js-10-2700-GOLD-BR</i>	<i>js-10-2700-BLACK-BR</i>	<i>Js-70-2700-COPPER-BR</i>
	12,5 x 2700	12,5 x 2700	12,5 x 2700	12,5 x 2700
	<i>Js-12-2700-SILVER-BR</i>	<i>Js-12-2700-GOLD-BR</i>	<i>Js-12-2700-BLACK-BR</i>	<i>Js-12-2700-COPPER-BR</i>

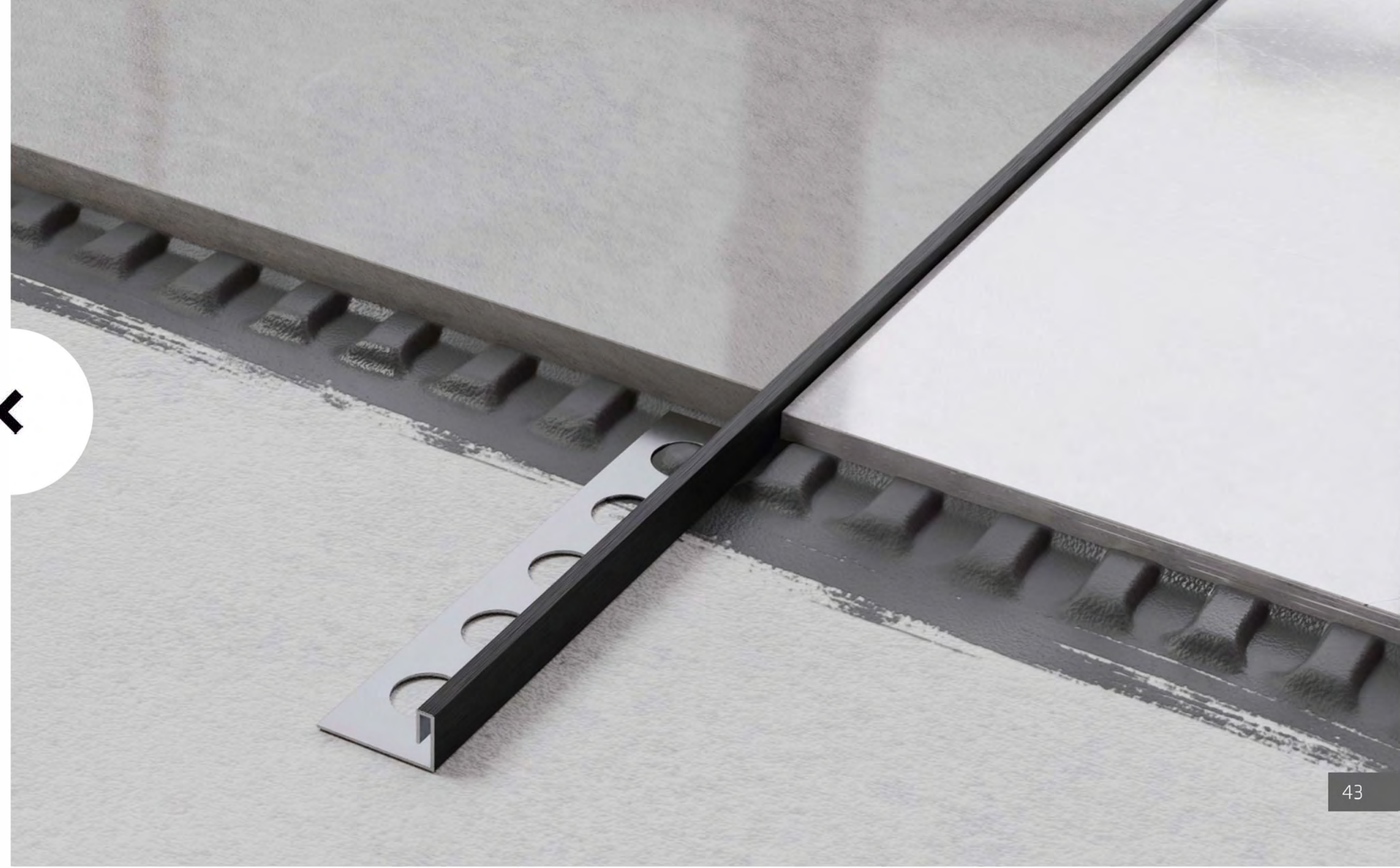

# "Qs" Profil

Szögletes Dekor sarokprofil

Fényes polír

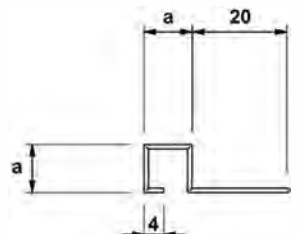

a = 10,5 vagy 12,5



Szín

magasság [mm]

cikkszám

Szín	EZÜST	ARANY	ANTRACIT	RÉZ
magasság [mm]	10,5 x 2700	10,5 x 2700	10,5 x 2700	10,5 x 2700
cikkszám	Qs-10-2700-SILVER-MI	Qs-10-2700-GOLD-MI	Qs-10-2700-BLACK-MI	Qs-10-2700-COPPER-MI
	12,5 x 2700	12,5 x 2700	12,5 x 2700	12,5 x 2700
	Qs-12-2700-SILVER-MI	Qs-12-2700-GOLD-MI	Qs-12-2700-BLACK-MI	Qs-12-2700-COPPER-MI

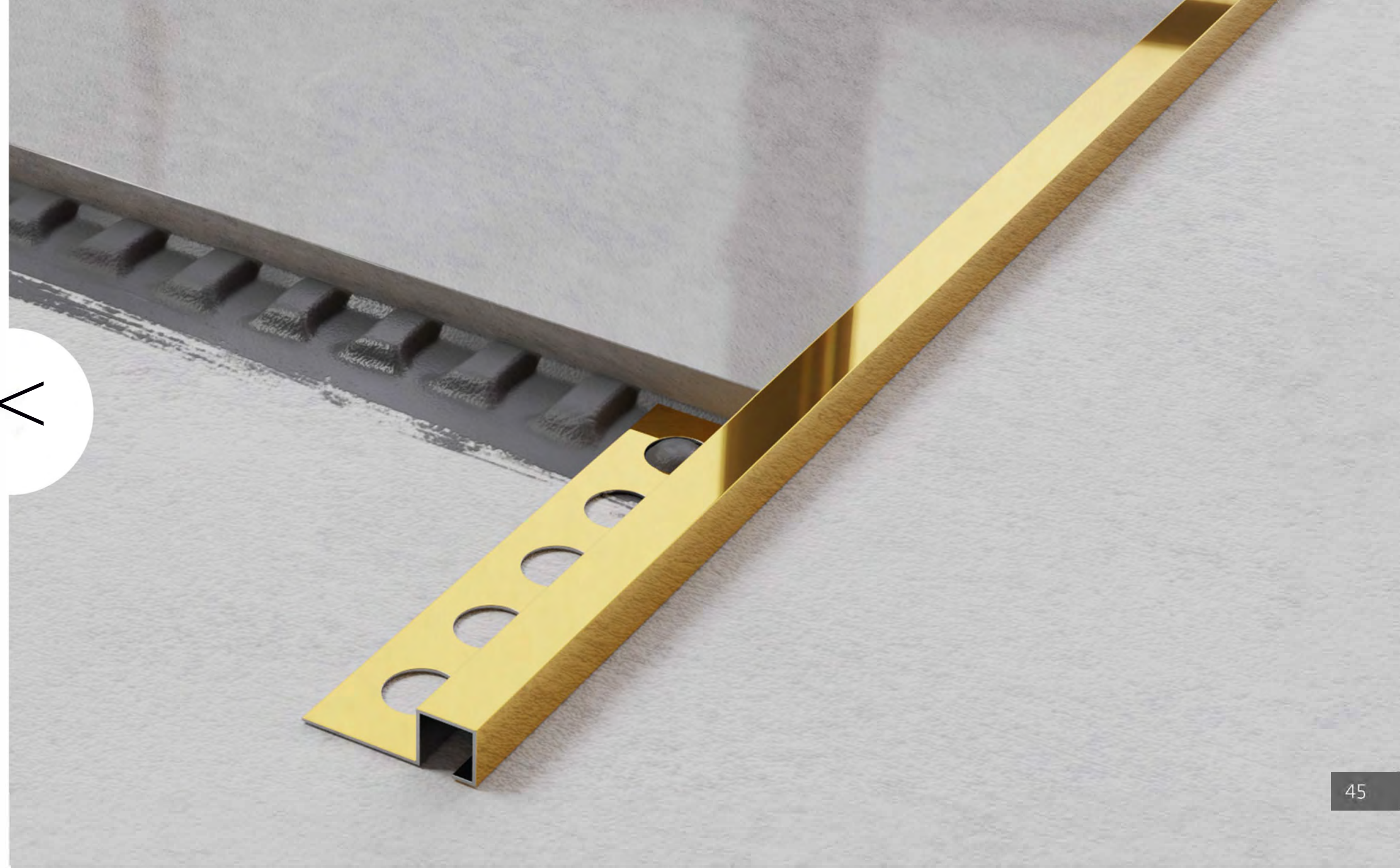

# "Qs" Profil

Szögletes Dekor sarokprofil

Fényes polír

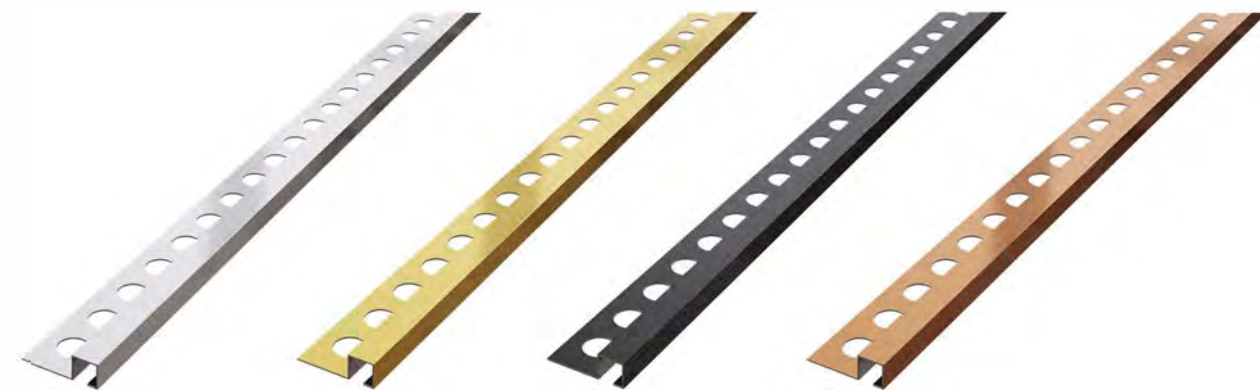
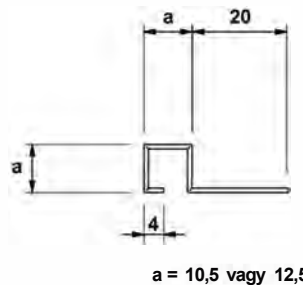

Szín

magasság [mm]  
cikkszám

Szín	EZÜST	ARANY	ANTRACIT	RÉZ
magasság [mm]	10,5 x 2700	10,5 x 2700	10,5 x 2700	10,5 x 2700
cikkszám	Qs-10-2700-SILVER-BR	Qs-10-2700-GOLD-BR	Qs-10-2700-BLACK-BR	Qs-10-2700-COPPER-BR
	12,5 x 2700	12,5 x 2700	12,5 x 2700	12,5 x 2700
	Qs-12-2700-SILVER-BR	Qs-12-2700-COLD-BR	Qs-12-2700-BLACK-BR	Qs-12-2700-COPPER-BR

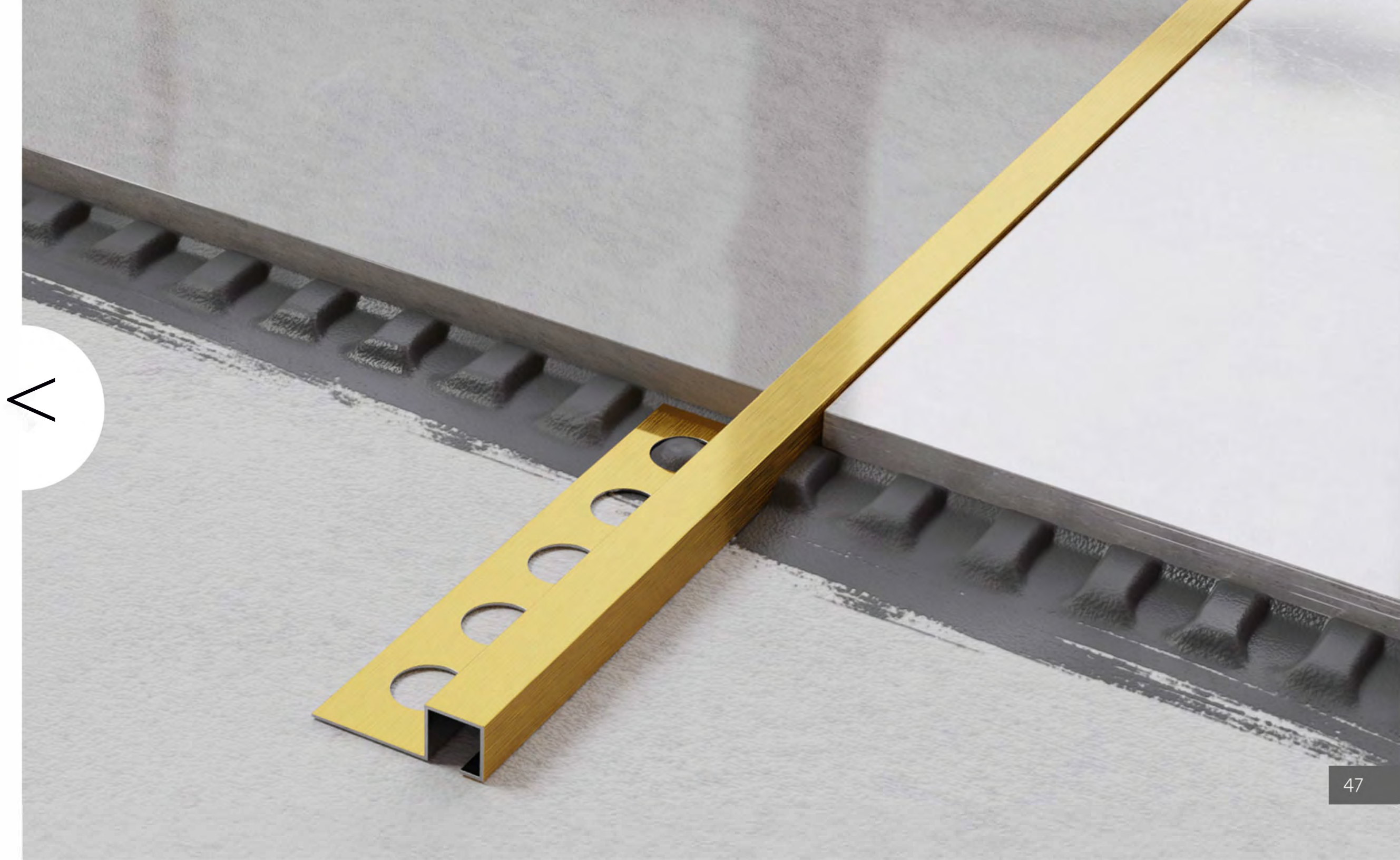

# "Rs" Profil

Szögletes 45° - os sarokprofil

Fényes polír

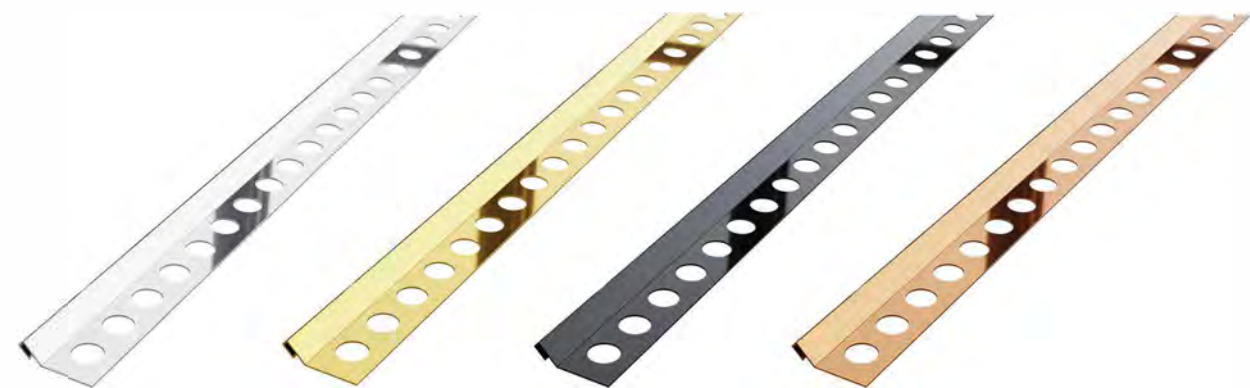
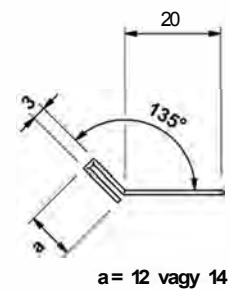

Szín

magasság [mm]  
cikkszám

Szín	EZÜST	ARANY	ANTRACIT	RÉZ
magasság [mm]	12 x 2700	12 x 2700	12 x 2700	12 x 2700
cikkszám	Rs-12-2700-SILVER-MI	Rs-12-2700-GOLD-MI	Rs-12-2700-BLACK-MI	Rs-12-2700-COPPER-MI
	14 x 2700	14 x 2700	14x2700	14x 2700
	Rs-14-2700-SILVER-MI	Rs-14-2700-GOLD-MI	Rs-14-2700-BLACK-MI	Rs-14-2700-COPPER-MI





# "Rs" Profil

Szögletes 45° - os sarokprofil

Szálcsiszolt

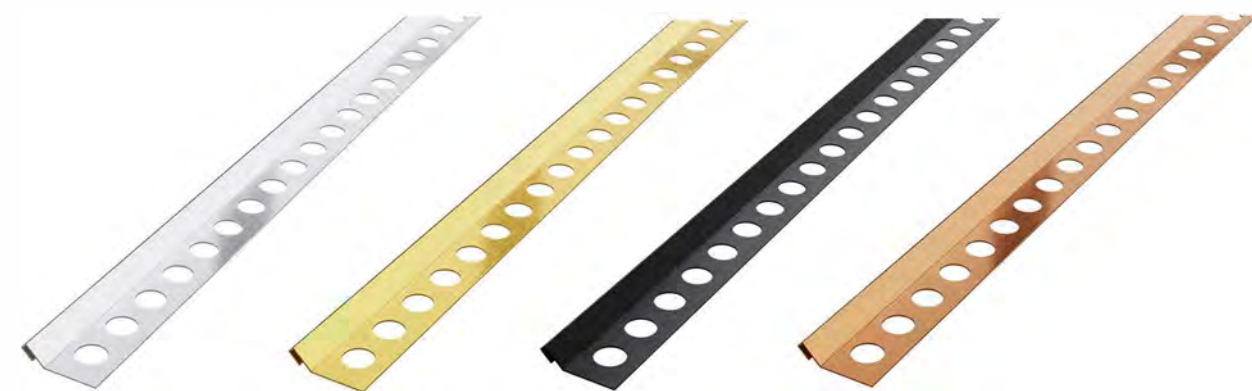
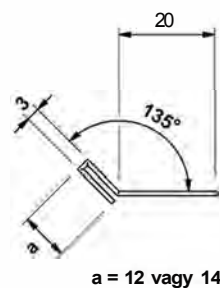

Szín

magasság [mm]  
cikkszám

	EZÜST	ARANY	ANTRACIT	RÉZ
12 x 2700	12 x 2700	12 x 2700	12 x 2700	12 x 2700
<i>Rs-12-2700-SILVER-BR</i>	<i>Rs-12-2700-GOLD-BR</i>	<i>Rs-12-2700-BLACK-BR</i>	<i>Rs-12-2700-COPPER-BR</i>	
14 x 2700	14 x 2700	14x2700	14x 2700	
<i>Rs-14-2700-SILVER-BR</i>	<i>Rs-14-2700-GOLD-BR</i>	<i>Rs-14-2700-BLACK-BR</i>	<i>Rs-14-2700-COPPER-BR</i>	



# "Ts" Profil

Szögletes T profil

Szálcsiszolt

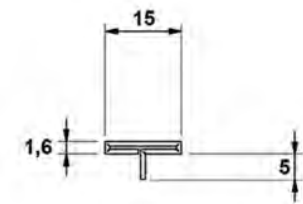

Szín

**szélesség [mm]**  
cikkszám

EZÜST

15 x 2700  
*Ts-15-2700-SILVER-MI*

ARANY

15 x 2700  
*Ts-15-2700-GOLD-MI*

ANTRACIT

15 x 2700  
*Ts-15-2700-BLACK-MI*

RÉZ

15 x 2700  
*Ts-15-2700-COPPER-MI*

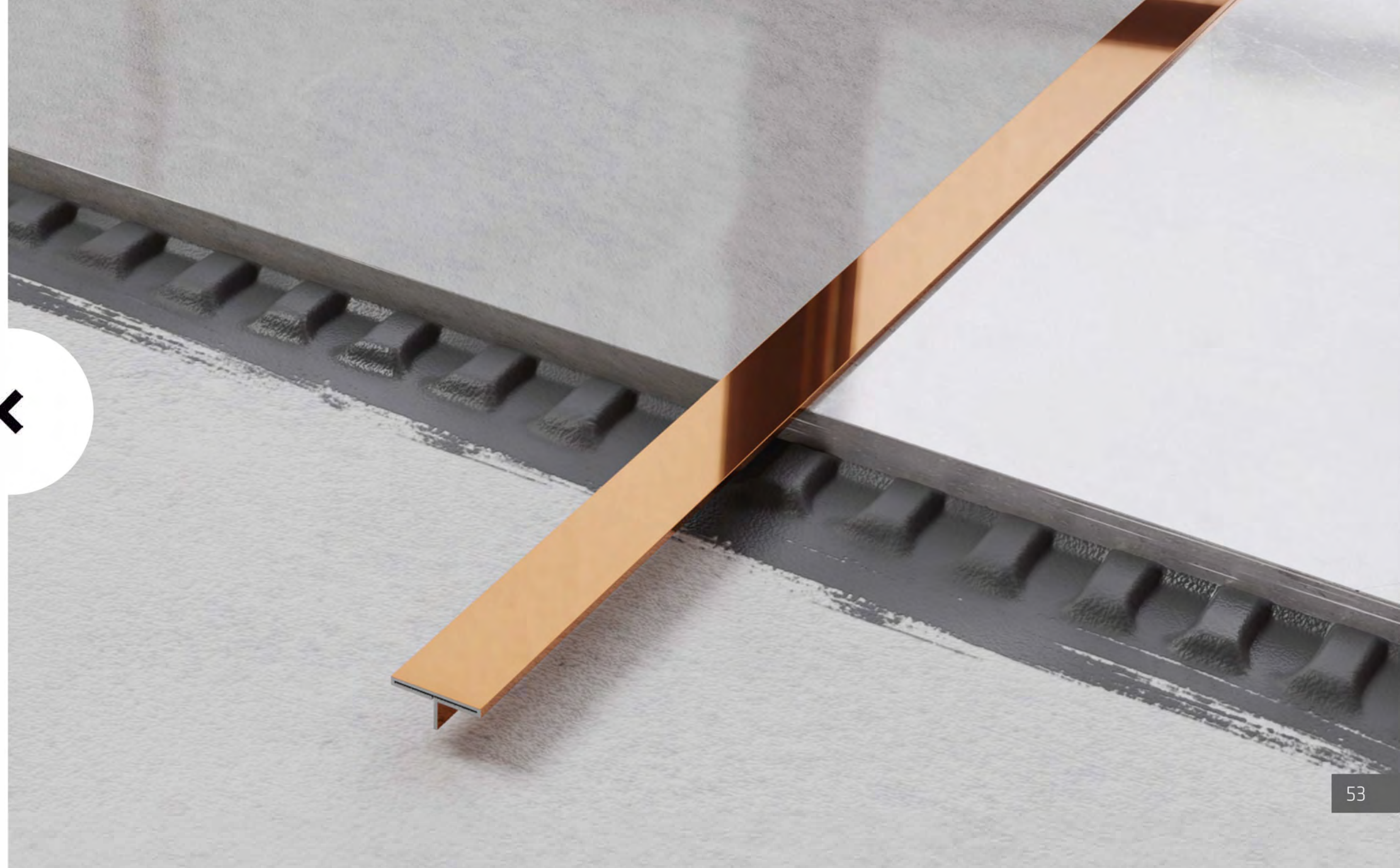

# "Ts" Profil

Szögletes T profil

Szálcsiszolt

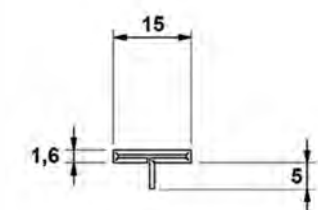

Szín

**szélesség [mm]**  
cikkszám

EZÜST

15 x 2700  
Ts-15-2700-SILVER-BR

ARANY

15 x 2700  
Ts-15-2700-GOLD-BR

ANTRACIT

15 x 2700  
Ts-15-2700-BLACK-BR

RÉZ

15 x 2700  
Ts-15-2700-COPPER-BR

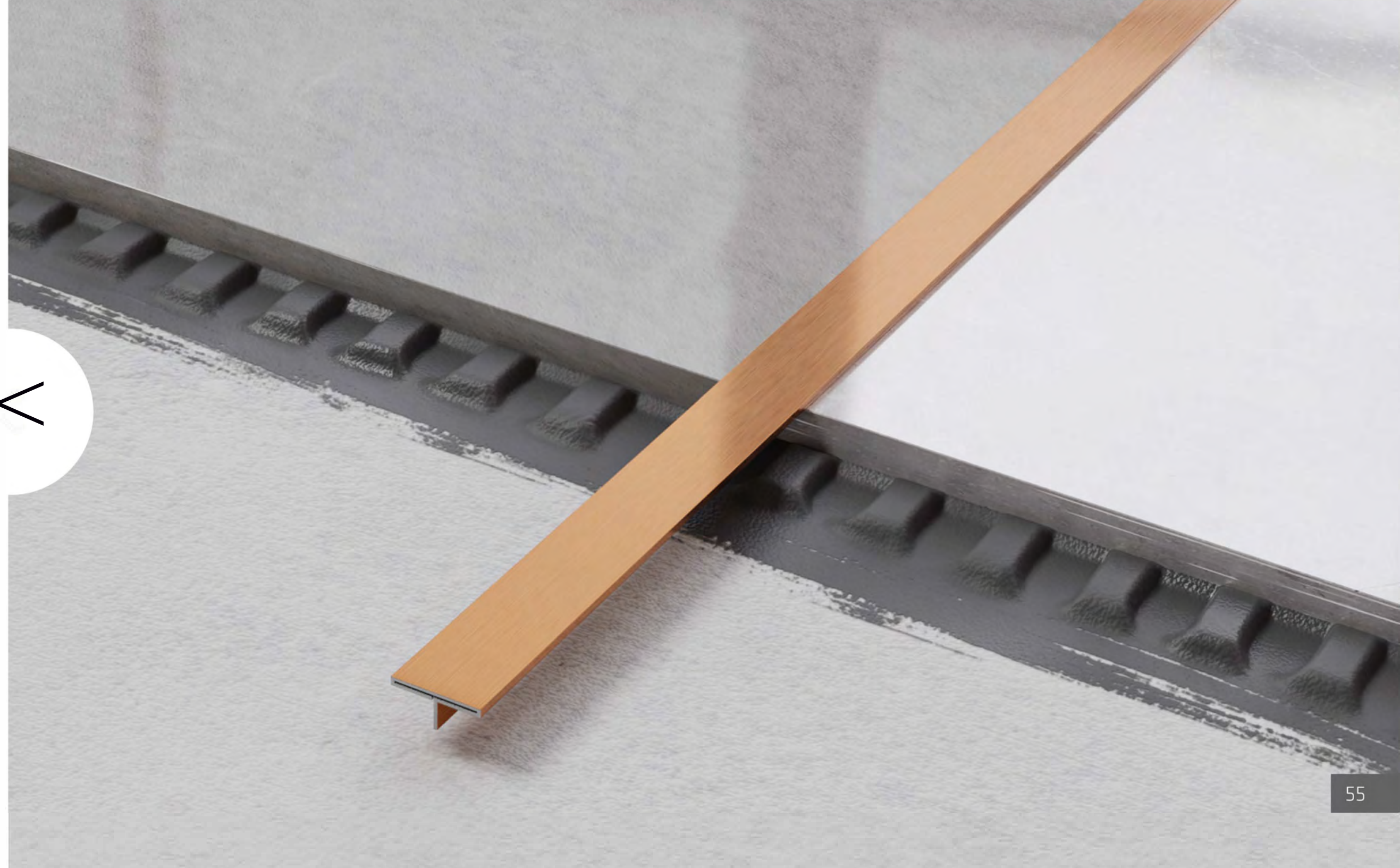
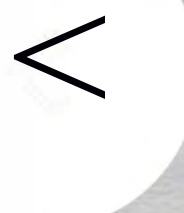

# BEÉPÍTETT ZUHANYPROFILOK

Lejtés kialakító-, dekor-, zuhany üvegprofilok



# "LK" Profil

Lejtésképző zuhanyprofil  
külső oldal

Fényes - polír

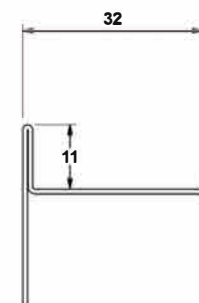

SZÍN	EZÜST	ARANY	ANTRACIT	RÉZ
<b>Méret [mm]</b>	<b>11 - 30 x 1200</b>	<b>11 - 30 x 1200</b>	<b>11 - 30 x 1200</b>	<b>11 - 30 x 1200</b>
<i>cikkszám</i>	<i>LKP-11-1200-SILVER-MI</i>	<i>LKP-11-1200-GOLD-MI</i>	<i>LKP-11-1200-BLACK-MI</i>	<i>LKP-11-1200-COPPER-MI</i>
Jobboldali, 2% lejtés	<b>11 - 40 x 1800</b>	<b>11 - 40 x 1800</b>	<b>11 - 40 x 1800</b>	<b>11 - 40 x 1800</b>
	<i>LKP-11-1800-SILVER-MI</i>	<i>LKP-11-1800-GOLD-MI</i>	<i>LKP-11-1800-BLACK-MI</i>	<i>LKP-11-1800-COPPER-MI</i>
<b>SZÍN</b>				
<b>méret [mm]</b>	<b>11 - 30 x 1200</b>	<b>11 - 30 x 1200</b>	<b>11 - 30 x 1200</b>	<b>11 - 30 x 1200</b>
<i>cikkszám</i>	<i>LKL-11-1200-SILVER-MI</i>	<i>LKL-11-1200-GOLD-MI</i>	<i>LKL-11-1200-BLACK-MI</i>	<i>LKL-11-1200-COPPER-MI</i>
Baloldali, 2% lejtés	<b>11 - 40 x 1800</b>	<b>11 - 40 x 1800</b>	<b>11 - 40 x 1800</b>	<b>11 - 40 x 1800</b>
	<i>LKL-11-1800-SILVER-MI</i>	<i>LKL-11-1800-GOLD-MI</i>	<i>LKL-11-1800-BLACK-MI</i>	<i>LKL-11-1800-COPPER-MI</i>

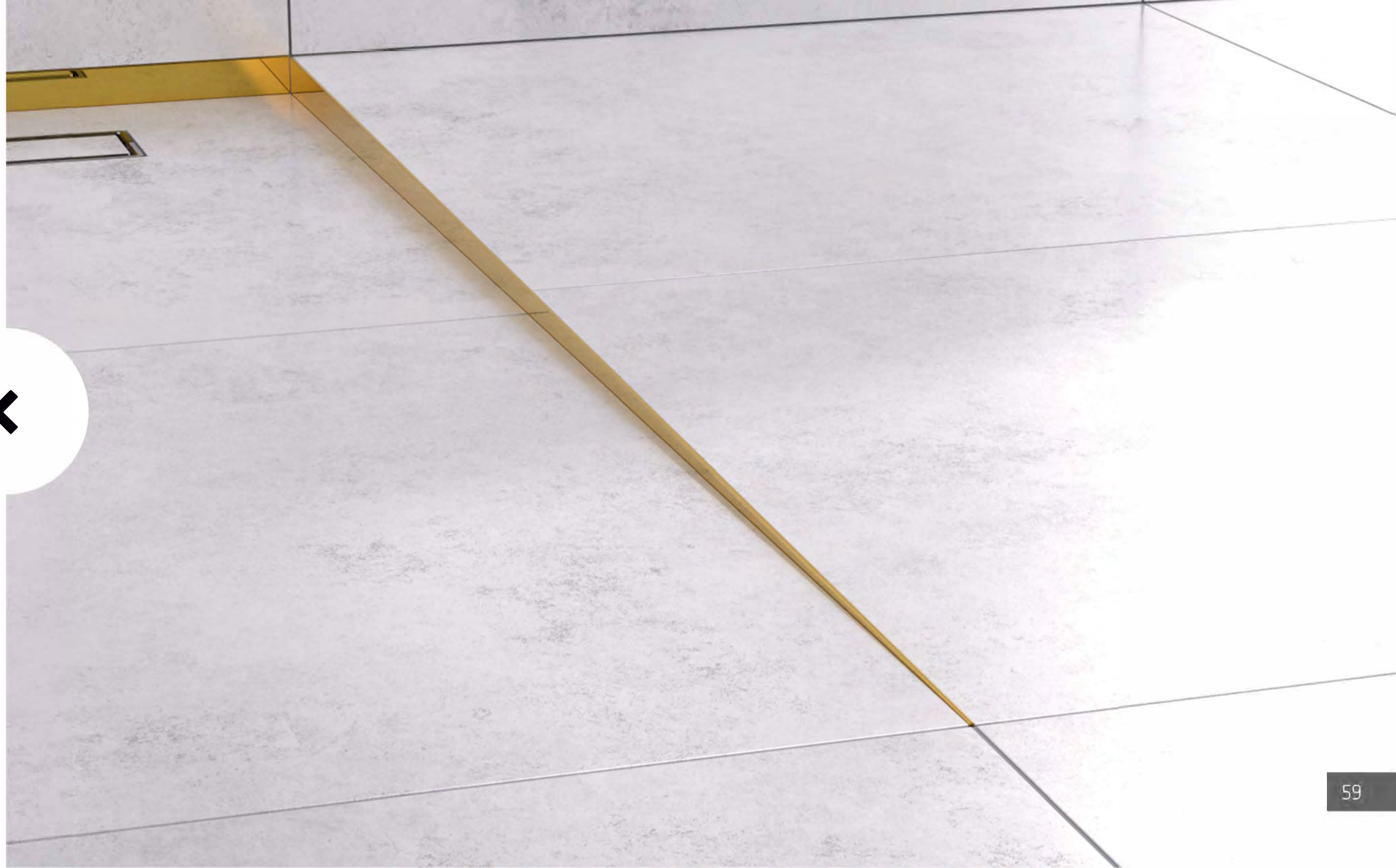

# "LK" Profil

Lejtésképző zuhanyprofil  
külső oldal

Szálcsiszolt

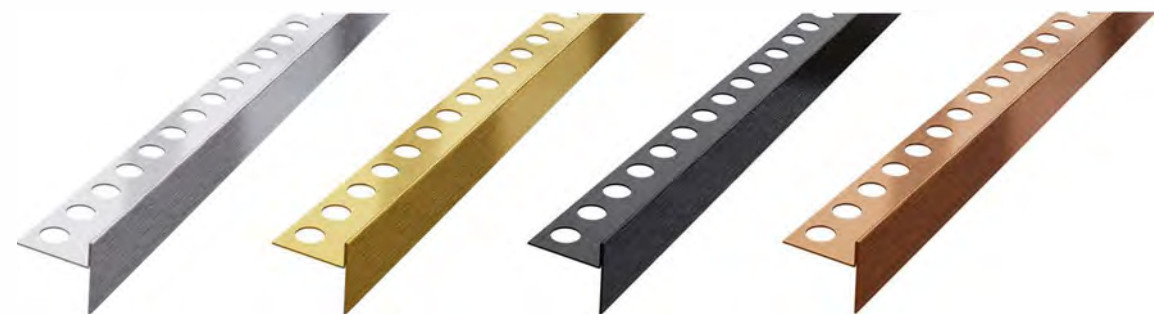
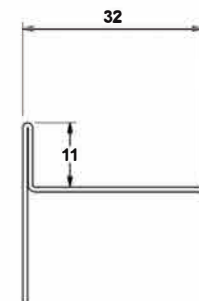

SZÍN

EZÜST

ARANY

ANTRACIT

RÉZ

Méret [mm]

11 - 30 x 1200

LKP-11-1200-SILVER-BR

11 - 30 x 1200

LKP-11-1200-GOLD-BR

11 - 30 x 1200

LKP-11-1200-BLACK-BR

11 - 30 x 1200

LKP-11-1200-COPPER-BR

cikkszám

11 - 40 x 1800

LKP-11-1800-SILVER-BR

11 - 40 x 1800

LKP-11-1800-GOLD-BR

11 - 40 x 1800

LKP-11-1800-BLACK-BR

11 - 40 x 1800

LKP-11-1800-COPPER-BR

Jobboldali,  
2% lejtés

SZÍN

11 - 30 x 1200

LKL-11-1200-SILVER-BR

11 - 30 x 1200

LKL-11-1200-GOLD-BR

11 - 30 x 1200

LKL-11-1200-BLACK-BR

11 - 30 x 1200

LKL-11-1200-COPPER-BR

méret [mm]

cikkszám

11 - 40 x 1800

LKL-11-1800-SILVER-BR

11 - 40 x 1800

LKL-11-1800-GOLD-BR

11 - 40 x 1800

LKL-11-1800-BLACK-BR

11 - 40 x 1800

LKL-11-1800-COPPER-BR

Baloldali,  
2% lejtés

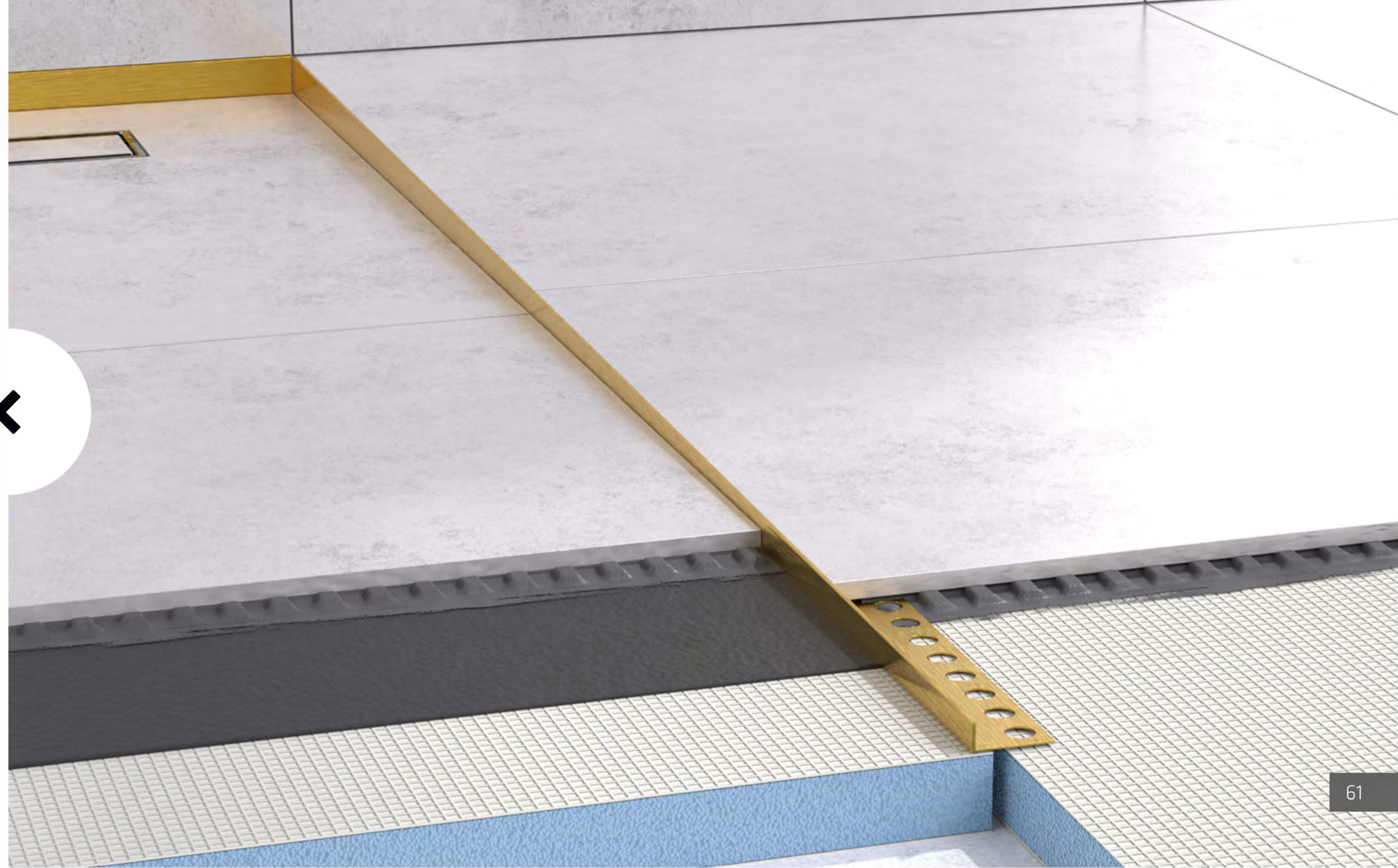

# "LPS" Profil

Lejtésképző zuhanyprofil  
beépíthető zuhanyüveghoz

Fényes - polír

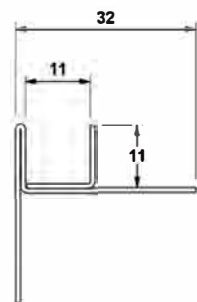

SZÍN

EZÜST

ARANY

ANTRACIT

RÉZ

**Méret [mm]**

**11 - 30 x 1200**

*LPSP-11-1200-SILVER-MI*

**11 - 30 x 1200**

*LPSP-11-1200-GOLD-MI*

**11 - 30 x 1200**

*LPSP-11-1200-BLACK-MI*

**11 - 30 x 1200**

*LPSP-11-1200-COPPER-MI*

*cikkszám*

**11 - 40 x 1800**

*LPSP-11-1800-SILVER-MI*

**11 - 40 x 1800**

*LPSP-11-1800-GOLD-MI*

**11 - 40 x 1800**

*LPSP-11-1800-BLACK-MI*

**11 - 40 x 1800**

*LPSP-11-1800-COPPER-MI*

Jobboldali,  
2% lejtés

SZÍN

**11 - 30 x 1200**

*LPSL-11-1200-SILVER-MI*

**11 - 30 x 1200**

*LPSL-11-1200-GOLD-MI*

**11 - 30 x 1200**

*LPSL-11-1200-BLACK-MI*

**11 - 30 x 1200**

*LPSL-11-1200-COPPER-MI*

*cikkszám*

**11 - 40 x 1800**

*LPSL-11-1800-SILVER-MI*

**11 - 40 x 1800**

*LPSL-11-1800-GOLD-MI*

**11 - 40 x 1800**

*LPSL-11-1800-BLACK-MI*

**11 - 40 x 1800**

*LPSL-11-1800-COPPER-MI*

Baloldali,  
2% lejtés



# "LPS" Profil

Lejtésképző zuhanyprofil  
beépíthető zuhanyüvegfalhoz

Szálcsiszolt

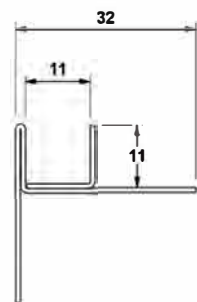

SZÍN	EZÜST	ARANY	ANTRACIT	RÉZ
<b>Méret [mm]</b>	<b>11 - 30 x 1200</b>	<b>11 - 30 x 1200</b>	<b>11 - 30 x 1200</b>	<b>11 - 30 x 1200</b>
<i>cikkszám</i>	<i>LPSP-11-1200-SILVER-BR</i>	<i>LPSP-11-1200-GOLD-BR</i>	<i>LPSP-11-1200-BLACK-BR</i>	<i>LPSP-11-1200-COPPER-BR</i>
Jobboldali, 2% lejtés	<b>11 - 40 x 1800</b>	<b>11 - 40 x 1800</b>	<b>11 - 40 x 1800</b>	<b>11 - 40 x 1800</b>
	<i>LPSP-11-1800-SILVER-BR</i>	<i>LPSP-11-1800-GOLD-BR</i>	<i>LPSP-11-1800-BLACK-BR</i>	<i>LPSP-11-1800-COPPER-BR</i>
<b>SZÍN</b>				
<b>méret [mm]</b>	<b>11 - 30 x 1200</b>	<b>11 - 30 x 1200</b>	<b>11 - 30 x 1200</b>	<b>11 - 30 x 1200</b>
<i>cikkszám</i>	<i>LPSL-11-1200-SILVER-BR</i>	<i>LPSL-11-1200-GOLD-BR</i>	<i>LPSL-11-1200-BLACK-BR</i>	<i>LPSL-11-1200-COPPER-BR</i>
Baloldali, 2% lejtés	<b>11 - 40 x 1800</b>	<b>11 - 40 x 1800</b>	<b>11 - 40 x 1800</b>	<b>11 - 40 x 1800</b>
	<i>LPSL-11-1800-SILVER-BR</i>	<i>LPSL-11-1800-GOLD-BR</i>	<i>LPSL-11-1800-BLACK-BR</i>	<i>LPSL-11-1800-COPPER-BR</i>

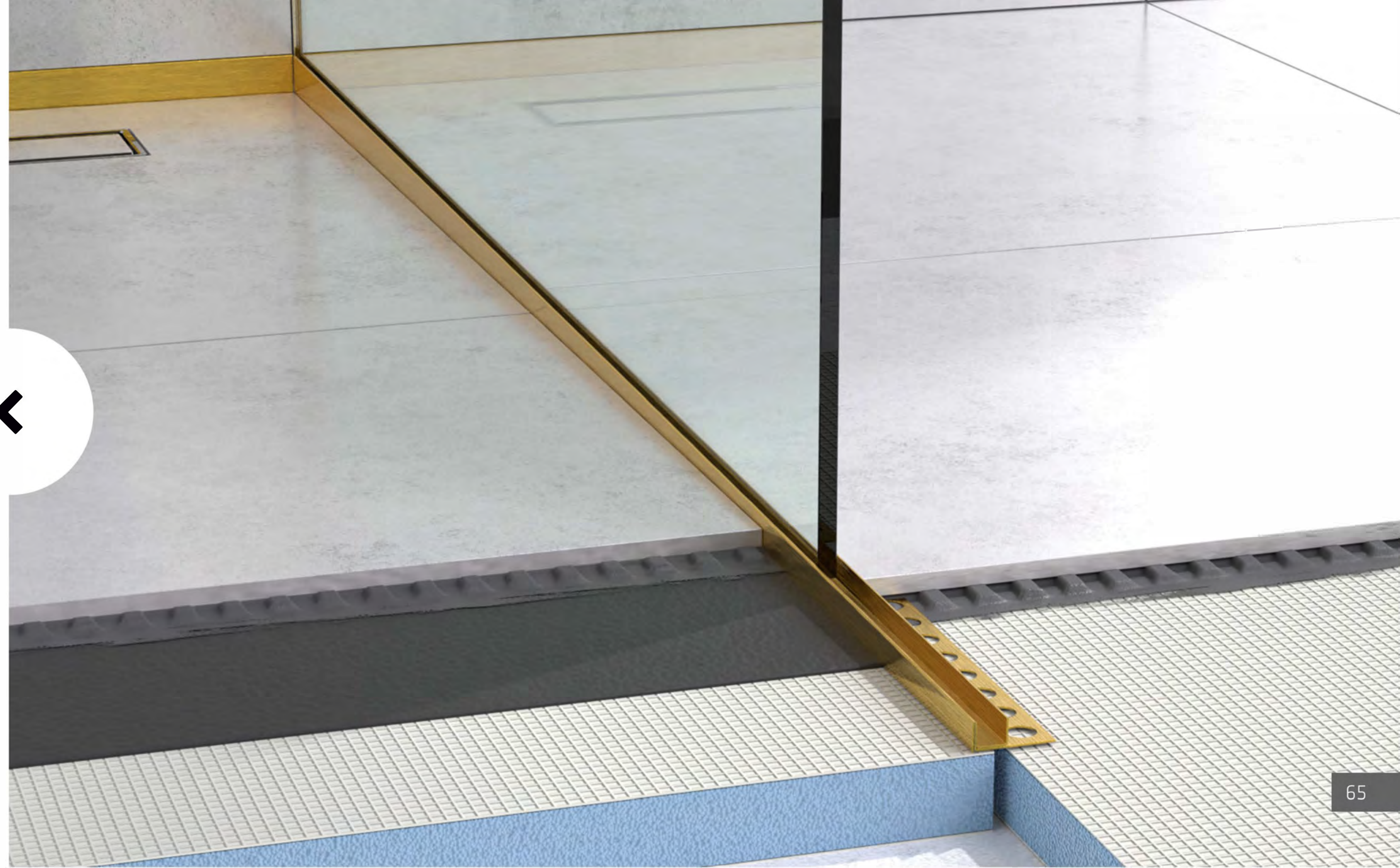



# "LSS" Profil

beépíthető zuhanyüvegfal  
profil

Fényes - polír

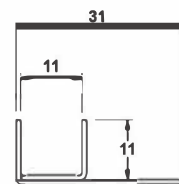

SZÍN

EZÜST

ARANY

ANTRACIT

RÉZ

Méret [mm]

**11 x 2000**

*LSS-11-2000-SILVER-MI*

**11 x 2000**

*LSS-11-2000-GOLD-MI*

**11 x 2000**

*LSS-11-2000-BLACK-MI*

**11 x 2000**

*LSS-11-2000-COPPER-MI*

cikkszám

**11 x 2400**

*LSS-11-2400-SILVER-MI*

**11 x 2400**

*LSS-11-2400-GOLD-MI*

**11 x 2400**

*LSS-11-2400-BLACK-MI*

**11 x 2400**

*LSS-11-2400-COPPER-MI*

8mm vastag üveghez



# "LSS" Profil

beépíthető zuhanyüvegfal  
profil

Szálcsiszolt

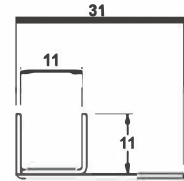

SZÍN

EZÜST

ARANY

ANTRACIT

RÉZ

Méret [mm]

**11 x 2000**

*LSS-11-2000-SILVER-BR*

**11 x 2000**

*LSS-11-2000-GOLD-BR*

**11 x 2000**

*LSS-11-2000-BLACK-BR*

**11 x 2000**

*LSS-11-2000-COPPER-BR*

cikkszám

**11 x 2400**

*LSS-11-2400-SILVER-BR*

**11 x 2400**

*LSS-11-2400-GOLD-BR*

**11 x 2400**

*LSS-11-2400-BLACK-BR*

**11 x 2400**

*LSS-11-2400-COPPER-BR*

8mm vastag üveghez

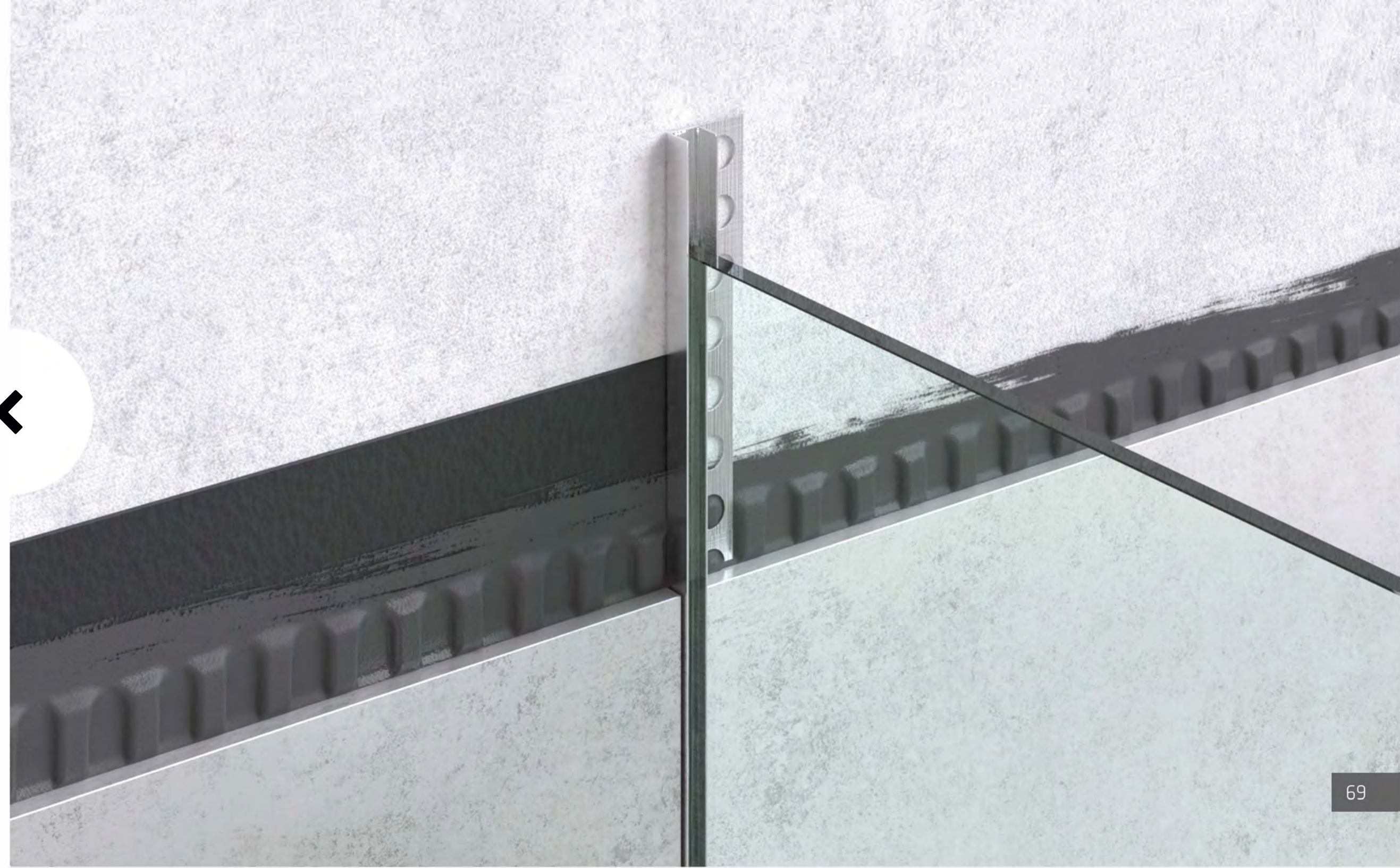

# "LS" Profil

Lejtésképző profil  
belső oldal (fali)

Fényes - polír

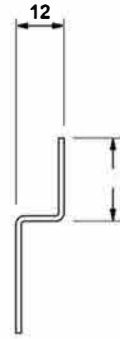

SZÍN	EZÜST	ARANY	ANTRACIT	RÉZ
<b>Méret [mm]</b>	<b>11 - 30 x 1200</b>	<b>11 - 30 x 1200</b>	<b>11 - 30 x 1200</b>	<b>11 - 30 x 1200</b>
<i>cikkszám</i>	<i>LSP-12-1200-SILVER-MI</i>	<i>LSP-12-1200-GOLD-MI</i>	<i>LSP-12-1200-BLACK-MI</i>	<i>LSP-12-1200-COPPER-MI</i>
Jobboldali, 2% lejtés	<b>11 - 40 x 1800</b>	<b>11 - 40 x 1800</b>	<b>11 - 40 x 1800</b>	<b>11 - 40 x 1800</b>
	<i>LSP-12-1800-SILVER-MI</i>	<i>LSP-12-1800-GOLD-MI</i>	<i>LSP-12-1800-BLACK-MI</i>	<i>LSP-12-1800-COPPER-MI</i>
<b>SZÍN</b>				
<b>méret [mm]</b>	<b>11 - 30 x 1200</b>	<b>11 - 30 x 1200</b>	<b>11 - 30 x 1200</b>	<b>11 - 30 x 1200</b>
<i>cikkszám</i>	<i>LSL-12-1200-SILVER-MI</i>	<i>LSL-12-1200-GOLD-MI</i>	<i>LSL-12-1200-BLACK-MI</i>	<i>LSL-12-1200-COPPER-MI</i>
Baloldali, 2% lejtés	<b>11 - 40 x 1800</b>	<b>11 - 40 x 1800</b>	<b>11 - 40 x 1800</b>	<b>11 - 40 x 1800</b>
	<i>LSL-12-1800-SILVER-MI</i>	<i>LSL-12-1800-GOLD-MI</i>	<i>LSL-12-1800-BLACK-MI</i>	<i>LSL-12-1800-COPPER-MI</i>



# "LS" Profil

Lejtésképző profil  
belső oldal (fali)

Szálcsiszolt

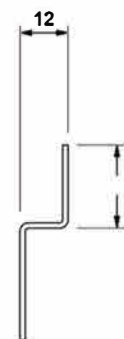

SZÍN	EZÜST	ARANY	ANTRACIT	RÉZ
<b>Méret [mm]</b>	<b>11 - 30 x 1200</b>	<b>11 - 30 x 1200</b>	<b>11 - 30 x 1200</b>	<b>11 - 30 x 1200</b>
<i>cikkszám</i>	<i>LSP-12-1200-SILVER-BR</i>	<i>LSP-12-1200-GOLD-BR</i>	<i>LSP-12-1200-BLACK-BR</i>	<i>LSP-12-1200-COPPER-BR</i>
Jobboldali, 2% lejtés	<b>11 - 40 x 1800</b>	<b>11 - 40 x 1800</b>	<b>11 - 40 x 1800</b>	<b>11 - 40 x 1800</b>
	<i>LSP-12-1800-SILVER-BR</i>	<i>LSP-12-1800-GOLD-BR</i>	<i>LSP-12-1800-BLACK-BR</i>	<i>LSP-12-1800-COPPER-BR</i>
<b>SZÍN</b>				
<b>méret [mm]</b>	<b>11 - 30 x 1200</b>	<b>11 - 30 x 1200</b>	<b>11 - 30 x 1200</b>	<b>11 - 30 x 1200</b>
<i>cikkszám</i>	<i>LSL-12-1200-SILVER-BR</i>	<i>LSL-12-1200-GOLD-BR</i>	<i>LSL-12-1200-BLACK-BR</i>	<i>LSL-12-1200-COPPER-BR</i>
Baloldali, 2% lejtés	<b>11 - 40 x 1800</b>	<b>11 - 40 x 1800</b>	<b>11 - 40 x 1800</b>	<b>11 - 40 x 1800</b>
	<i>LSL-12-1800-SILVER-BR</i>	<i>LSL-12-1800-GOLD-BR</i>	<i>LSL-12-1800-BLACK-BR</i>	<i>LSL-12-1800-COPPER-BR</i>



# "LC" Profil

Lejtéskepző profilt összekötő dekorprofil

Fényes - polír

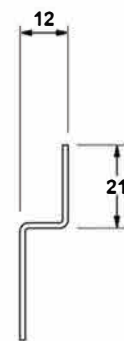

SZÍN

Méret [mm]  
cikkszám

EZÜST	ARANY	ANTRACIT	RÉZ
<b>30 x 1300</b> <i>LC-12-1300-SILVER-MI</i>	<b>30 x 1300</b> <i>LC-12-1300-GOLD-MI</i>	<b>30 x 1300</b> <i>LC-12-1300-BLACK-MI</i>	<b>30 x 1300</b> <i>LC-12-1300-COPPER-MI</i>
<b>40 x 1800</b> <i>LC-12-1800-SILVER-MI</i>	<b>40 x 1800</b> <i>LC-12-1800-GOLD-MI</i>	<b>40 x 1800</b> <i>LC-12-1800-BLACK-MI</i>	<b>40 x 1800</b> <i>LC-12-1800-COPPER-MI</i>

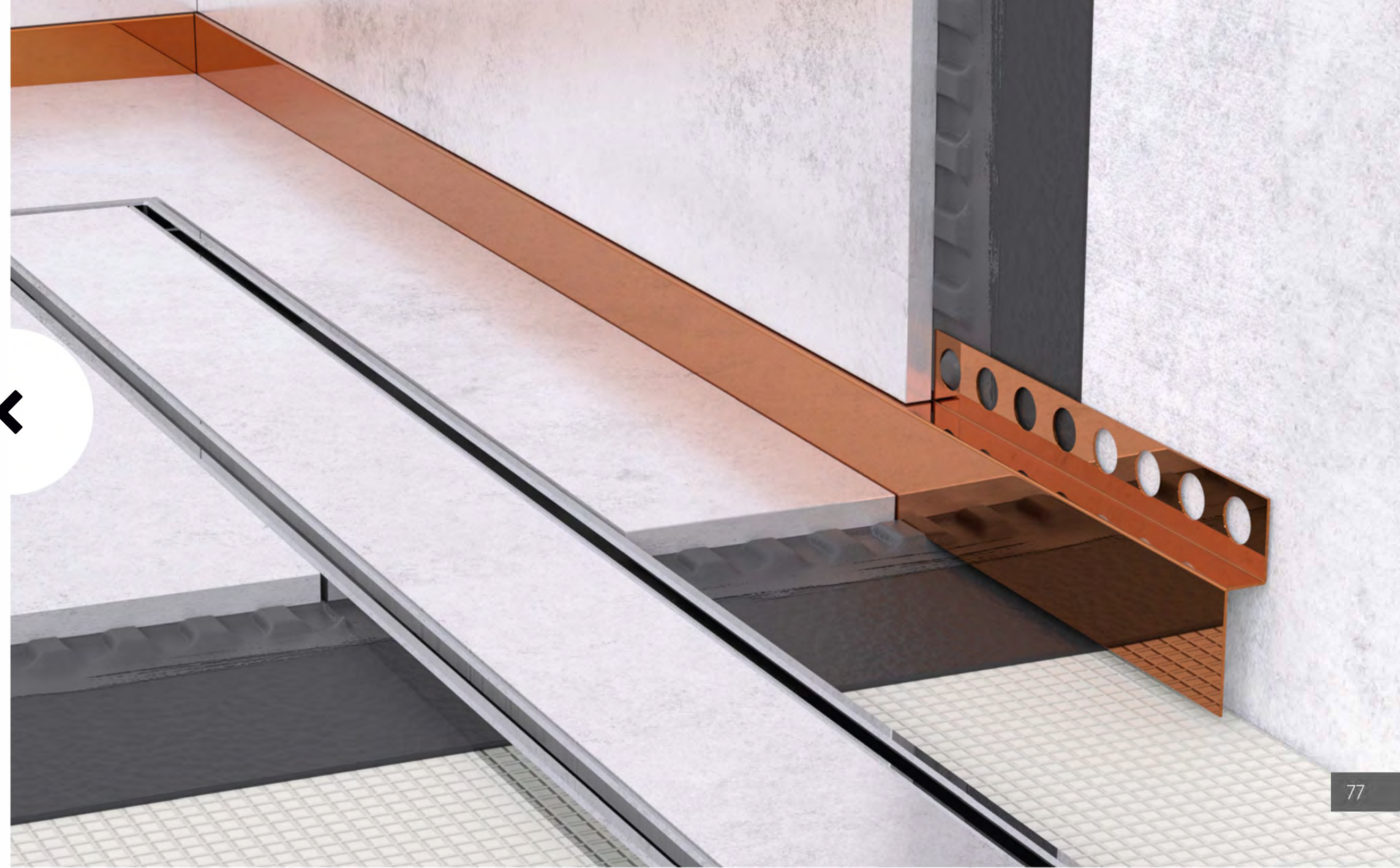

# "LC" Profil

Lejtésképző profil összekötő  
dekorprofil

Szálcsiszolt

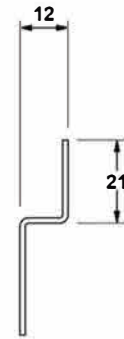

SZÍN

Méret [mm]  
cikkszám

EZÜST	ARANY	ANTRACIT	RÉZ
<b>30 x 1300</b> <small>LC-12-1300-SILVER-MI</small>	<b>30 x 1300</b> <small>LC-12-1300-GOLD-MI</small>	<b>30 x 1300</b> <small>LC-12-1300-BLACK-MI</small>	<b>30 x 1300</b> <small>LC-12-1300-COPPER-MI</small>
<b>40 x 1800</b> <small>LC-12-1800-SILVER-MI</small>	<b>40 x 1800</b> <small>LC-12-1800-GOLD-MI</small>	<b>40 x 1800</b> <small>LC-12-1800-BLACK-MI</small>	<b>40 x 1800</b> <small>LC-12-1800-COPPER-MI</small>

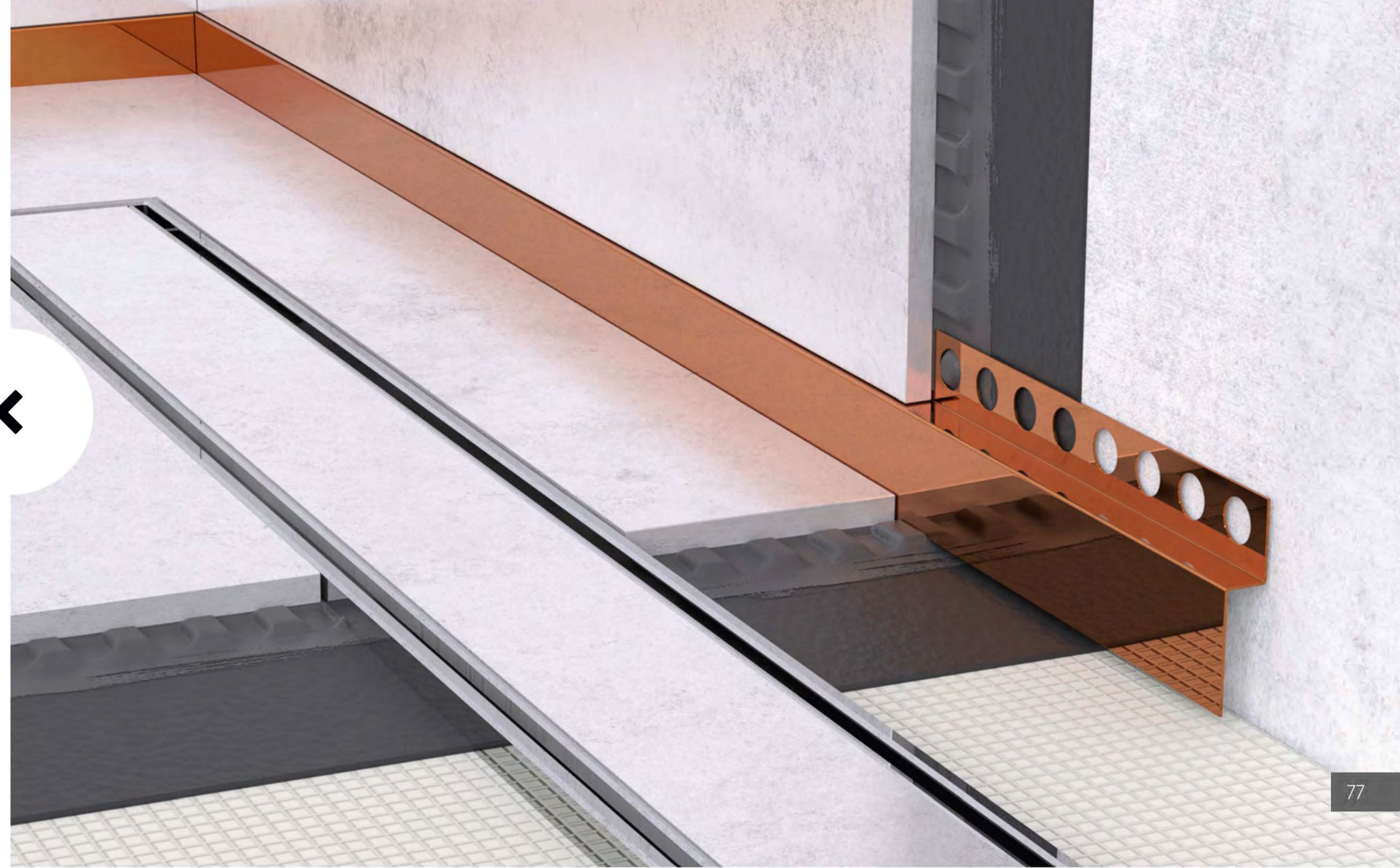

# "LM" Profil

Zuhanyüveg tartó profil

Fényes - polír

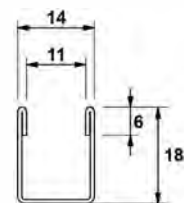

SZÍN

Méret [mm]

cikkszám

EZÜST

**11 x 2700**

LM-11-2700-SILVER-MI

ARANY

**11 x 2700**

LM-11-2700-GOLD-MI

ANTRACIT

**11 x 2700**

LM-11-2700-BLACK-MI

RÉZ

**11 x 2700**

LM-11-2700-COPPER-MI



# "LM" Profil

Zuhanyüveg tartó profil

Szálcsiszolt

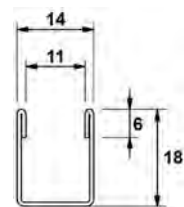

SZÍN

Méret [mm]

cikkszám

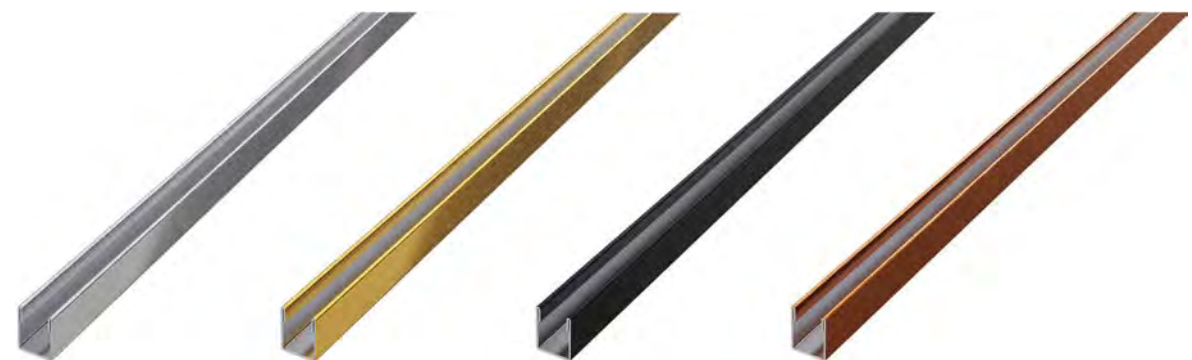

EZÜST

11 x 2700

LM-11-2700-SILVER-BR

ARANY

11 x 2700

LM-11-2700-GOLD-BR

ANTRACIT

11 x 2700

LM-11-2700-BLACK-BR

RÉZ

11 x 2700

LM-11-2700-COPPER-BR





# HEXAGON

Öntapadós dekoratív elem

Fényes - polír

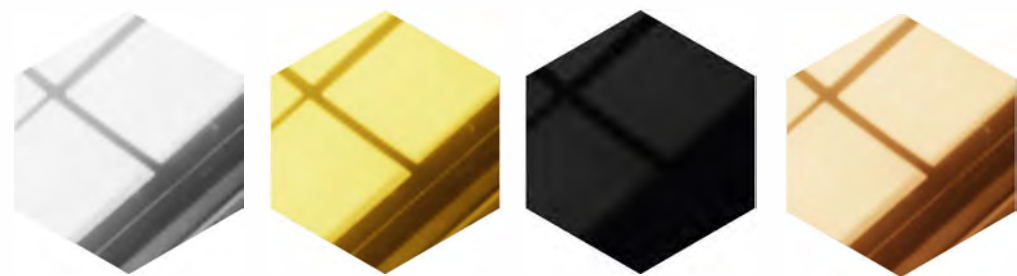

SZÍN

Méret [mm]

cikkszám

EZÜST

120 x 140

HEX-120-140-SILVER-MI

ARANY

120 x 140

HEX-120-140-GOLD-MI

ANTRACIT

120 x 140

HEX-120-140-BLACK-MI

RÉZ

120 x 140

HEX-120-140-COPPER-MI



# HEXAGON

Öntapadós dekoratív elem

Szálcsiszolt



SZÍN

Méret [mm]

cikkszám

EZÜST

120 x 140

HEX-120-140-SILVER-BR

ARANY

120 x 140

HEX-120-140-GOLD-BR

ANTRACIT

120 x 140

HEX-120-140-BLACK-BR

RÉZ

120 x 140

HEX-120-140-COPPER-BR



# GYIK

## Válaszok a leggyakrabban feltett kérdésekre

### **A kapott lécek szürkének és tompának tűnnek, valami baj van velük?**

Nem - a terméken lévő szürke fólia véd a karcolások ellen. A termék színének ellenőrzéséhez óvatosan emelje fel a fóliát.

A terméket védőfóliával együtt szerelje fel; azt csak a beszerelés után vagy a beszerelés utolsó szakaszában távolítsa el. A díszlécek gyártásához használt acél a díszítőfelület egyik oldalán polírozott. Az termék szerelési oldalán a lézervágás okozta karcolások és elszíneződések találhatóak - ez nem termékhiba.

### **A díszléceket be kell fugázni?**

Erre nincs szükség. A szegélyléceket és profilokat úgy tervezték, hogy fugázóhabarcs nélkül szereljük fel, de ha a dekorációt fugázni szeretné, ügyeljen arra, hogy ezt csak olyan epoxi fugázóhabarccsal tegye, amely nem tartalmaz csiszoló részecskéket, pl. cementet vagy csillámot, amelyek megkarcolhatják a szegélyléc dekoratív ismétlését.

A fugázás előtt végezzen próbát a dekoráció egy nem feltűnő részén, hogy megbizonyosodjon arról, hogy a fugázás nem károsítja a terméket.

### **Milyen ragasztót használjak hozzá?**

Profiljainkhoz a SIKAFLEX 118 ragasztót vagy más rögzítő ragasztót, például a népszerű "Mammoth" ragasztót ajánljuk.

Az általunk kínált profilok egy része perforált, így a dekorációk "beleolvadhatnak" a csemperagasztóba.

### **Hogyan lehet méretre vágni a profilokat?**

Profiljainkat saját maga is méretre vághatja, pl. fémvágó tárcsával ellátott szerszámcsiszolóval, ferde vágókoronggal vagy fűrészlappal.

### **Használhatom a profilokat kültéren, például egy épület homlokzatán?**

Igen, de ne feledje, hogy a ScJ-formázóelemek hajlamosak a karcolódásra - kerülje a használatát olyan területeken, ahol mechanikai sérüléseknek lehetnek kitéve, pl. bokrokhoz dörzsölve.

### **Szükség van-e a díszlécek impregnálására?**

Nem. A rozsdamentes acél, amelyből a profilok készülnek, nem igényelnek impregnálást.

### **Hogyan tisztíthatom meg a profilokat?**

Profiljaink könnyen tisztíthatók olyan háztartási tisztítószerrel, amelyek nem károsítják a polírozott felületeket. Puha mikroszálas kendő és tiszta víz használatát javasoljuk.

Rozsdamentes acél tisztítására alkalmas tisztítószerket is vásárolhat. Mindig kövesse a használati utasítást.

Ne feledje, hogy a profilok nagyon magas vegyszerállósággal rendelkeznek, de nagyon érzékenyek a karcolásokra - soha ne használjon "CIF" típusú vegyszereket vagy drótsúrológépeket.

- Ez a díszítés felületének elszíneződését okozná.